

Yealink



HD IP Conference Phone CP960

Version 80.35
Nov. 2017

Copyright

Copyright © 2017 YEALINK (XIAMEN) NETWORK TECHNOLOGY

Copyright © 2017 Yealink (Xiamen) Network Technology CO., LTD. All rights reserved. No parts of this publication may be reproduced or transmitted in any form or by any means, electronic or mechanical, photocopying, recording, or otherwise, for any purpose, without the express written permission of Yealink (Xiamen) Network Technology CO., LTD. Under the law, reproducing includes translating into another language or format.

When this publication is made available on media, Yealink (Xiamen) Network Technology CO., LTD. gives its consent to downloading and printing copies of the content provided in this file only for private use but not for redistribution. No parts of this publication may be subject to alteration, modification or commercial use. Yealink (Xiamen) Network Technology CO., LTD. will not be liable for any damages arising from use of an illegally modified or altered publication.

Trademarks

Yealink®, the logo and the name and marks is trademark of Yealink (Xiamen) Network Technology CO., LTD, which are registered legally in China, the United States, EU (European Union) and other countries.

All other trademarks belong to their respective owners. Without Yealink's express written permission, recipient shall not reproduce or transmit any portion hereof in any form or by any means, with any purpose other than personal use.

Warranty

(1) Warranty

THE SPECIFICATIONS AND INFORMATION REGARDING THE PRODUCTS IN THIS GUIDE ARE SUBJECT TO CHANGE WITHOUT NOTICE. ALL STATEMENTS, INFORMATION, AND RECOMMENDATIONS IN THIS GUIDE ARE BELIEVED TO BE ACCURATE AND PRESENTED WITHOUT WARRANTY OF ANY KIND, EXPRESS OR IMPLIED. USERS MUST TAKE FULL RESPONSIBILITY FOR THEIR APPLICATION OF PRODUCTS.

(2) Disclaimer

YEALINK (XIAMEN) NETWORK TECHNOLOGY CO., LTD. MAKES NO WARRANTY OF ANY KIND WITH REGARD TO THIS GUIDE, INCLUDING, BUT NOT LIMITED TO, THE IMPLIED WARRANTIES OF MERCHANTABILITY AND FITNESS FOR A PARTICULAR PURPOSE. Yealink (Xiamen) Network Technology CO., LTD. shall not be liable for errors contained herein nor for incidental or consequential damages in connection with the furnishing, performance, or use of this guide.

(3) Limitation of Liability

Yealink and/or its respective suppliers are not responsible for the suitability of the information contained in this document for any reason. The information is provided "as is", and Yealink does not provide any warranty and is subject to change without notice. All risks other than risks caused by use of the information are borne by the recipient. In no event, even if Yealink has been suggested the occurrence of damages that are direct, consequential, incidental, special, punitive or whatsoever (Including but not limited to loss of business profit, business interruption or loss of business information), shall not be liable for these damages.

End User License Agreement

This End User License Agreement ("EULA") is a legal agreement between you and Yealink. By installing, copying or otherwise using the Products, you: (1) agree to be bounded by the terms of this EULA, (2) you are the owner or an authorized user of the device, and (3) you represent and warrant that you have the right, authority and capacity to enter into this agreement and to abide by all its terms and conditions, just as if you had signed it. The EULA for this product is available on the Yealink Support page for the product.

Patent Information

China, the United States, EU (European Union) and other countries are protecting one or more patents of accompanying products and/or patents being applied by Yealink.

Customer Feedback

We are striving to improve our documentation quality and we appreciate your feedback. Email your opinions and comments to DocsFeedback@yealink.com.

Technical Support

Visit Yealink WIKI (<http://support.yealink.com>) for the latest firmware, guides, FAQ, Product documents, and more. For better service, we sincerely recommend you to use Yealink Ticketing system (<https://ticket.yealink.com>) to submit all your technical issues.

GNU GPL INFORMATION

Yealink CP960 HD IP Conference Phone firmware contains third-party software under the GNU General Public License (GPL). Yealink uses software under the specific terms of the GPL. Please refer to the GPL for the exact terms and conditions of the license.

The original GPL license, source code of components licensed under GPL and used in Yealink products can be downloaded online:

<http://www.yealink.com/GPLOpenSource.aspx?BaseInfoCateId=293&NewsCateId=293&CateId=293>.

About This Guide

Thanks for choosing Yealink CP960 IP conference phone, which comprises the power of the Android 5.1 operating system and is exquisitely designed for medium-to-large conference room. CP960 is a 5-inch touchable conference phone which simply putting all of the key conferencing functions at your fingertips, allowing users to enjoy its powerful business telephony features, such as Call Hold, Call Transfer, Call and Conference Recording, Multicast Paging and five-way Conference over an IP network. Meanwhile, users can benefit from two optional expansion microphones for wider voice pickup range.

This guide provides everything you need to quickly use your new phone. First, verify with your system administrator that the IP network is ready for phone configuration. Also be sure to read the Packaging Contents in this guide, and see the [Yealink Products Regulatory Notices guide](#) for all regulatory and safety guidance before you set up and use the CP960 IP phone.

In This Guide

Topics provided in this guide include:

- Chapter 1 [Overview](#)
- Chapter 2 [Getting Started](#)
- Chapter 3 [Customizing Your Phone](#)
- Chapter 4 [System Applications](#)
- Chapter 5 [Basic Phone Features](#)
- Chapter 6 [Advanced Phone Features](#)
- Chapter 7 [Connecting Bluetooth Devices and PC](#)
- Chapter 8 [Using the CP Wireless Expansion Mic CPW90](#)

Summary of Changes

This section describes the changes to this guide for each release and guide version.

Changes for Release 80, Guide Version 80.35

Documentations of the released CP Wired Expansion Mic CPE90 have been deleted.

Major updates have occurred to the following sections:

- [Line Key Features](#) on page 107
- [Connecting a Mobile Phone Using Bluetooth](#) on page 226

Changes for Release 80, Guide Version 80.25

Major updates have occurred to the following section:

- [Pairing and Connecting the Bluetooth-Enabled Mobile Phone](#) on page 228

Table of Contents

About This Guide v

In This Guide	v
Summary of Changes	v
Changes for Release 80, Guide Version 80.35	v
Changes for Release 80, Guide Version 80.25	vi

Table of Contents..... vii

Overview 13

Hardware Component Instructions	13
Icon Instructions	15
Feature Status Icons.....	15
Line Key Icons.....	16
Other Icons	19
LED Instructions.....	20
User Interfaces	20
Phone User Interface.....	20
Web User Interface.....	21
Documentations	23

Getting Started..... 25

Packaging Contents	25
Optional Accessories	26
Phone Installation	27
Connect the Power and Wired Network.....	28
Connect the Optional PC.....	28
Connect the Optional USB Flash Drive.....	29
Connect the Optional External Speaker.....	29
Phone Initialization.....	29
Registration	30
Using the Touch Screen	30
Idle Screen	30
Dialing Screen	33
Calls Screen	34
Configuration Screen	35
Control Center/Notification Center	36

Navigating Menus and Fields	38
Entering Data and Editing Fields.....	39
Using the Onscreen Keyboard.....	39
Using the Onscreen Dial Pad	44
Phone Status.....	44
Basic Network Settings.....	46
Wireless Network Settings	49
Connecting to the Wireless Network.....	49
Viewing the Connected Wireless Network Information	55
Disconnecting the Wireless Network.....	55
Disabling Wi-Fi Feature	56
Customizing Your Phone.....	58
General Settings	58
Wallpaper.....	58
Screen Saver.....	60
Power Saving	61
Backlight.....	64
Language.....	66
Input Method	67
Time & Date.....	68
Administrator Password	70
Phone Lock.....	71
Audio Settings.....	75
Volume.....	75
Ring Tones.....	77
Key Tone.....	80
Touch Sounds.....	80
Notification Sound	81
Silent Mode	81
Contact Management	82
Local Directory	83
Blacklist	95
Remote Phone Book.....	97
Call History Management.....	99
Viewing History Records.....	99
Placing a Call from History Records	100
Adding a Contact to the Blacklist.....	100
Deleting History Records.....	101
Disabling History Records	103
Search Source List in Dialing	103
System Customizations.....	104
Line Keys.....	104
Account Management	113

Dial Plan.....	115
Emergency Number.....	121
Live Dialpad.....	121
Hotline.....	122
FWD International	123
System Applications	124
Recorder	124
Recording Audios	124
Playing the Recorded Audios.....	125
Copying Recorded Audios to USB Flash Drive.....	126
Renaming the Recorded Audios.....	128
Deleting the Recorded Audios	128
Checking Storage Space	129
Browser	130
Browsing a Web Page	130
Managing Bookmarks	131
Setting a Home Page	133
Clearing the Navigation History.....	134
Modifying Browser Settings	135
Clock.....	135
Basic Phone Features	138
Placing Calls	139
Placing a Call	139
Placing Multiple Calls	140
Placing a Mobile Call over Bluetooth	140
Answering Calls.....	142
Answering When Not in Another Call	142
Answering When in Another Call	142
Answer Calls Automatically.....	142
Handling Incoming Calls.....	144
Silencing an Incoming Call.....	144
Rejecting an Incoming Call	144
Rejecting Calls with Do Not Disturb (DND) Enabled	144
Forwarding Incoming Calls	146
Ending Calls.....	149
Speed Dial.....	149
Recent Call In Dialing	150
Auto Redial	152
Call Completion	153
Recall.....	154
Call Mute/Unmute.....	155

Call Hold/Resume	157
Call Transfer.....	159
Blind Transfer.....	159
Semi-Attended Transfer.....	160
Attended Transfer.....	161
Call Waiting	161
Conference	162
Local Conference	162
Network Conference.....	168
Call Park	169
Call Pickup	171
Directed Call Pickup.....	171
Group Call Pickup	173
Anonymous Call	175
Anonymous Call Rejection	176
Advanced Phone Features.....	180
Busy Lamp Field (BLF).....	180
Configuring the BLF Feature on the Phone	180
Using BLF Feature on the Phone	184
BLF List	186
Call Recording	188
Call and Conference Recording (Local).....	188
Call Recording (Server Side)	191
Hot Desking	193
Intercom	195
Configuring the Intercom Feature on the Phone.....	195
Using Intercom Feature on the Phone	197
Multicast Paging.....	198
Sending RTP Stream	198
Receiving RTP Stream	202
Using Multicast Paging.....	203
Music on Hold.....	205
Shared Call Appearance (SCA).....	207
Configuring SCA Feature on the IP Phone	208
Using SCA Feature on the IP Phone	213
Message.....	221
Voice Mail	221
Message Waiting Indicator (MWI)	223
Connecting Bluetooth Devices and PC.....	226
Connecting a Mobile Phone Using Bluetooth.....	226
Activating/Deactivating the Bluetooth Mode	226

Pairing and Connecting the Bluetooth-Enabled Mobile Phone.....	228
Making/Receiving a Mobile Call on the IP Phone	229
Using Your IP Phone as Bluetooth Speaker	230
Renaming the Paired Bluetooth Device.....	231
Making the IP Phone Discoverable.....	231
Editing Device Information	232
Disconnecting the Bluetooth Device.....	233
Unpairing the Mobile Phone.....	233
Connecting a PC Using a USB Cable	234
Connecting the PC Audio	235
Managing the PC Audio.....	236
Setting the IP Phone as PC Audio Device	238
Removing the PC Audio.....	239
Using the CP Wireless Expansion Mic CPW90.....	241
Placing the CPW90	241
Turning the CPW90 On or Off	242
Registering/Unregistering the CPW90	242
Muting or Unmuting the CPW90.....	244
Idle Mode	244
Viewing CPW90 Information	244
Finding the CPW90.....	245
Charging the CPW90	245
CPW90 LED Instructions.....	246
CPW90 Working Frequency.....	247
Appendix A - Time Zones.....	249
Index	251

Overview

This chapter provides the overview of the CP960 IP phone. Topics include:

- [Hardware Component Instructions](#)
- [Icon Instructions](#)
- [LED Instructions](#)
- [User Interfaces](#)
- [Documentations](#)

If you require additional information or assistance with your new phone, contact your system administrator.

Hardware Component Instructions

The following figure shows the primary hardware component of CP960 IP phone:

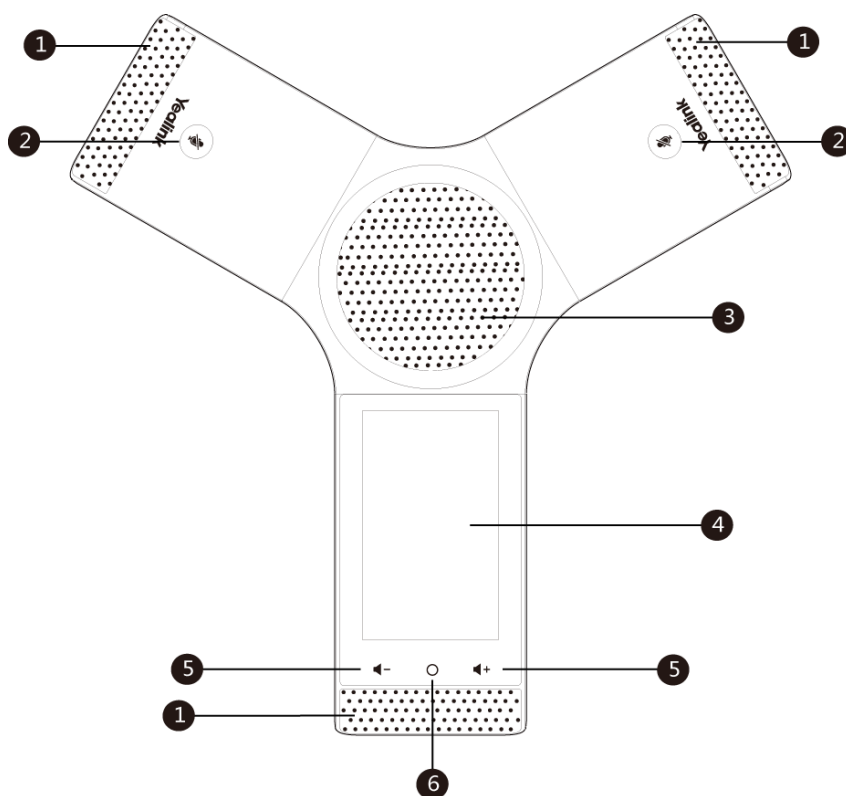

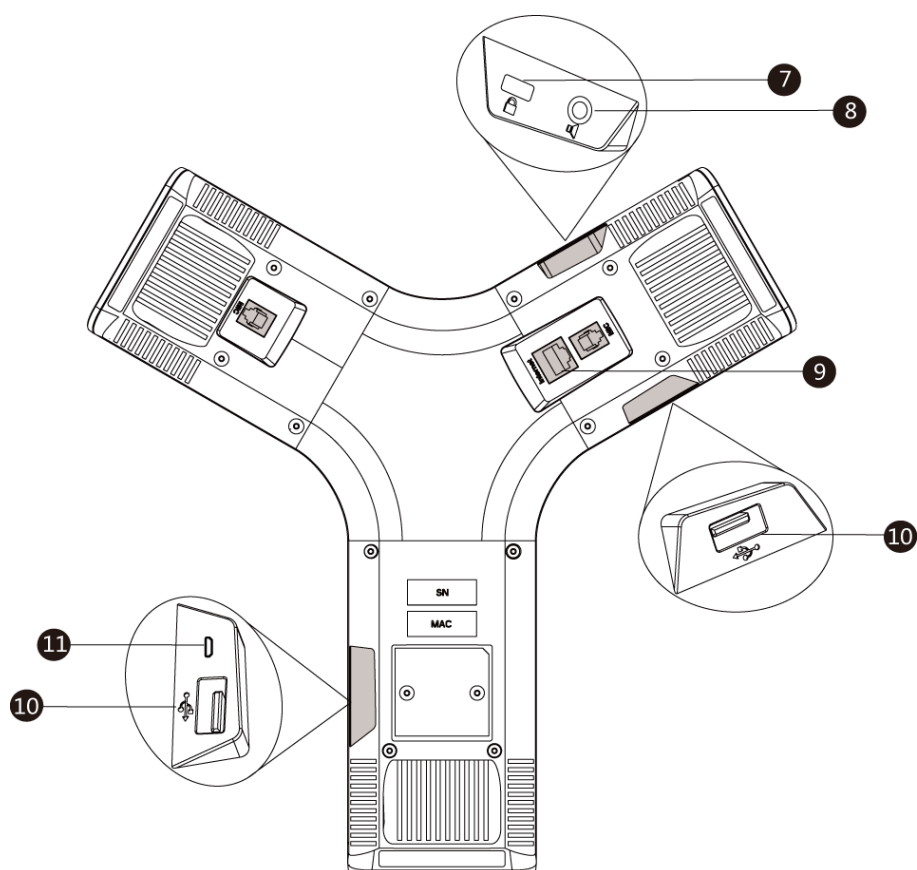

Hardware component instructions of the phone are:













	Item	Description
①	Three Internal Microphones	Provide 20-foot and 360-degree coverage to transmit sound to other phones.
②	Mute Touch Keys	<ul style="list-style-type: none"> • Indicate phone statuses. • Toggle mute feature.
③	Speaker	Provides hands-free (speakerphone) audio output.
④	Touch Screen	5 inch (720 x 1280) capacitive (5 point) touch screen with two idle screens. Tap to select items and navigate menus. Shows information about calls, messages, time, date and other relevant data: <ul style="list-style-type: none"> • Call information—caller ID, call duration • Icons (for example, ) • Missed call list or second incoming caller information • Prompt text (for example, "Save successfully!") • Time and date
⑤	Volume Touch Keys	Adjust the volume of the speaker, ringer or media.
⑥	HOME Touch Key	Returns to the idle screen.
⑦	Security Slot	Allows you to connect a universal security cable to your phone so you can lock down your phone. The phone will not be removed after locked.

	Item	Description
⑧	3.5mm Audio-out Port	Allows you to connect an optional external speaker.
⑨	Network Port	Allows you to connect the IP phone to wired network.
⑩	USB Ports	Allow you to connect an optional USB flash drive or CPW90 charging cradle.
⑪	Micro USB Port	Allows you to connect a PC and turn CP960 into an external speaker and microphone for your PC.

Icon Instructions

Feature Status Icons

















Icons appearing on the status bar are described in the following table:



Icons	Description
	Unavailable wired network
	Voice Mail
	Auto Answer
	Do Not Disturb
	Call Forward
	Silent mode
	Keep Mute
	Phone Lock
	Missed Calls
	Bluetooth enabled
	Bluetooth-enabled mobile phone paired and connected
	Wi-Fi enabled
	Wi-Fi signal strength from weak to strong after connecting successfully

Icons	Description
	USB flash drive detected





Line Key Icons

Icon indicator (associated with line key features):



Icons	Description
	Hold/Public Hold Private Hold
	DND
	Voice Mail
	Direct Pickup
	Group Pickup
	DTMF Prefix
	LDAP Local Group XML Group
	XML Browser
	Forward
	ReCall
	Record URL Record
	Recording starts successfully (Record/URL Record)
	Multicast Paging Paging List
	Hot Desking
	Zero Touch
	URL

Icons	Description
	Phone Lock
	Directory
	Speed Dial





Icon indicator (associated with line)



Icons	Description
	Registered private line
	Register failed
 (Flashing)	Registering
	Registered shared line

Icon indicator (associated with mobile account)





Icons	Description
	Mobile Account (Bluetooth-Enabled mobile phone is both paired and connected)
	Mobile Account (Bluetooth-Enabled mobile phone fails to connect)
 (Flashing)	Mobile Account (Bluetooth-Enabled mobile phone is connecting)

Icon indicator (associated with BLF/BLF List)

Icons	Description
	BLF/BLF list idle state
 (Flashing)	BLF/BLF list ringing state
 (Flashing)	BLF/BLF list callout state
	BLF/BLF list talking state







Icons	Description
	BLF hold state
	BLF list call park state
	BLF/BLF list failed state





Icon indicator (associated with Intercom)

Icons	Description
	Intercom idle state
	Intercom ringing state
 Callout	Intercom callout state
 Talking	Intercom talking state
	Intercom failed state

Icon indicator (associated with a shared line)





The local SCA phone indicates the phone is involved in an SCA call, while the monitoring SCA phone indicates the phone is not involved in the SCA call.

Icon	Description
	The shared line is idle.
 (for monitoring SCA phone)	The shared line is seized.
 (Flashing)	The shared line receives an incoming call.
 (Flashing)	The shared line is dialing.
	The shared line is in conversation.
	The shared line conversation is placed on public hold.





Icon	Description
 (for local SCA phone)	The shared line conversation is placed on private hold.
 (for monitoring SCA phone)	
	The shared line conversation is barged in by the other shared line party.
	For a multi-party call, all the shared line parties participating in this call place the shared line conversation on hold.

Other Icons



Icon indicator (associated with call recording)

Icons	Description
	Recording box is full (Using a record key)
	A call cannot be recorded (Using a record key)
	Recording starts successfully (Using a record key)
	Recording cannot be started (Using a record key)
	Recording cannot be stopped (Using a record key)

Icon indicator (associated with call history)

Icons	Description
	Received Calls
	Placed Calls
	Missed Calls
	Forwarded Calls

Icon indicator (associated with contact)

Icons	Description
	The default local caller photo
	The default mobile caller photo

LED Instructions

Mute key indicators LED on the CP960 IP phone:

LED Status	Description
Solid red	The phone is initializing. The phone is muted.
Flashing red	The phone is ringing.
Solid green	The phone is placing a call. There is an active call on the phone.
Off	The phone is powered off. The phone is idle.

User Interfaces

Two ways to customize configurations of your CP960 IP phone:

- The user interface on the IP phone.
- The user interface in a web browser on your PC.

You can perform all call operation tasks and configure basic settings directly on the phone. In addition, you can use the web user interface to access all configuration settings. In many cases, it is possible to use either the phone user interface and/or the web user interface interchangeably. However, in some cases, only one interface is available to operate the phone and change settings.

Phone User Interface

You can customize your phone by tapping **Settings** from the Home screen. The **Advanced** option is only accessible to the administrator, and the default administrator password is "admin" (case-sensitive). For more information on customizing your phone with the available options via phone user interface, refer to [Customizing Your Phone](#) on page 58.

Web User Interface

In addition to the phone user interface, you can also customize your phone via web user interface. In order to access the web user interface, you need to know the IP address of your new phone. To obtain the IP address, tap **Settings** and then tap **General** from the **Status** block on the phone. Enter the IP address (e.g., `http://192.168.0.10` or `192.168.0.10` for IPv4; `http://[2005:1:1:1:215:65ff:fe64:6e0a]` or `[2005:1:1:1:215:65ff:fe64:6e0a]` for IPv6) in the address bar of a web browser on your PC. The default administrator user name and password are both "admin" (case-sensitive).

Note

The access to the Advanced settings of the Account or Network via web user interface may be blocked by the web browser (e.g., Chrome, Firebox) if you have installed "Adblock Plus plugin".

The main options you can use to customize the IP phone via phone user interface and/or via web user interface are listed in the following table:

Options	Phone User Interface	Web User Interface
Status		
--IPv4		
--MAC		
--Firmware	✓	✓
--Network		
--Phone		
--Accounts		
Basic Phone Settings		
--Wallpaper	✓	✓
--Screen Saver	✓	×
--Power Saving	×	
--Backlight	✓	✓
--Language	✓	
--Input Method	✓	×
--Time & Date	✓	
--Administrator Password	✓	
--Phone Lock	✓	✓
--Audio Settings		
--Ring Tones	✓	
--Key Tone	✓	
--Touch Sounds	✓	
--Notification Sound	✓	×
--Silent Mode	✓	
--Contact Management		✓
--Local Directory	✓	

Options	Phone User Interface	Web User Interface
--Blacklist	√	
--Remote Phone Book	×	
--Call History Management	√	
--Search Source List in Dialing	×	
--Line Keys	√	
--Account Management	√	
--Dial Plan	×	√
--Emergency Number	×	
--Live Dialpad	×	
--Hotline	√	
--FWD International	√	
System Applications		
--Recorder	√	
--Browser	√	×
--Clock	√	
Basic Call Features		
--Auto Answer	√	
--Speed Dial	√	
--Recent Call In Dialing	×	
--Auto Redial	√	
--Call Completion	√	
--ReCall	√	
--Do Not Disturb (DND)	√	
--Call Forward	√	√
--Call Transfer	√	
--Call Waiting	√	
--Conference	√	
--Call Park	√	
--Call Pickup	√	
--Anonymous Call	√	
--Anonymous Call Rejection	√	
Advanced Phone Features		
--Busy Lamp Field (BLF)	√	
--BLF List	×	
--Call Recording	√	
--Hot Desking	√	
--Intercom	√	
--Multicast Paging	×	√
--Music on Hold	×	
--Shared Call Appearance (SCA)	×	
--Message	√	

Options	Phone User Interface	Web User Interface
SIP Account		√
--User Options		
--Activation	√	
--Label	√	
--Display Name	√	
--Register Name	√	
--User Name	√	
--Password	√	
--Server Options		
--SIP Server1/2	√	
--Register Port	×	
--Outbound Status	√	
--Outbound Proxy1/2	√	
--Fallback Interval	√	
--NAT Status	√	

Note The table above only lists the main feature options. Please refer to the relevant sections for more information.

Documentations

The following table shows documentations available for the CP960 IP phone.

Name	Contents	Where found	Language
Quick Start Guide	Basic call features and phone customizations	In the package/On the website	English/Chinese
User Guide	Phone/Web user interface settings Basic call features and advanced phone features	On the website	English/Chinese

Note You can also download the latest documentations online:
<http://support.yealink.com/documentFront/forwardToDocumentDetailPage>.

Getting Started

This chapter provides the following basic installation instructions and information for obtaining the best performance with the CP960 IP phone. Topics include:

- [Packaging Contents](#)
- [Phone Installation](#)
- [Phone Initialization](#)
- [Registration](#)
- [Using the Touch Screen](#)
- [Entering Data and Editing Fields](#)
- [Phone Status](#)
- [Basic Network Settings](#)
- [Wireless Network Settings](#)

If you require additional information or assistance with your new phone, contact your system administrator.

Packaging Contents

The following components are included in your CP960 IP phone package:

- **IP Phone**

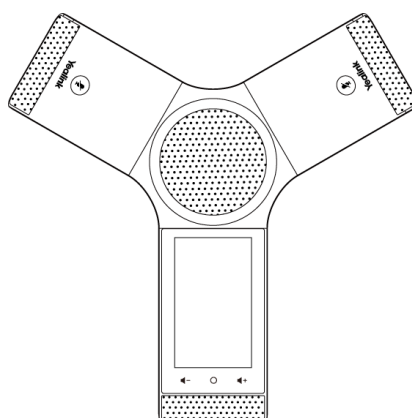

- **Ethernet Cable (7.5m CAT5E UTP cable)**

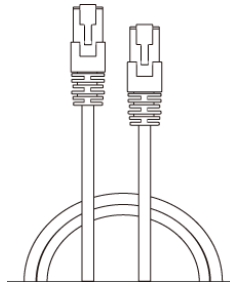

- **Quick Start Guide**

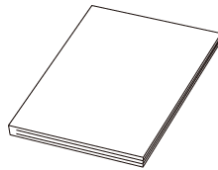

Check the list before installation. If you find anything missing, contact your system administrator.

Optional Accessories

The following items are optional accessories for your CP960 IP phone. You need to purchase them separately if required.

- **PoE Adapter**



Yealink

PSE

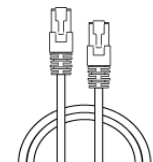

**Ethernet Cable
(2m CAT5E FTP cable)**

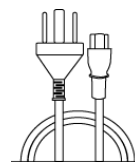

Power Cord

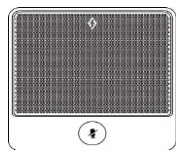
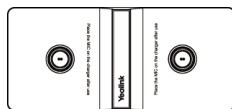
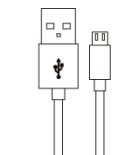
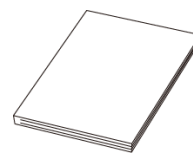
• CPW90 Package**Wireless Expansion
Mic x 2****Charging Cradle****0.3m Micro USB
Cable****Quick Start Guide****Note**

We recommend that you use the accessories provided or approved by Yealink. The use of unapproved third-party accessories may result in reduced performance.

Phone Installation

If your phone is already installed, proceed to [Phone Initialization](#) on page 29.

This section introduces how to install the phone:

- 1) Connect the power and wired network
- 2) Connect the optional PC
- 3) Connect the optional USB flash drive
- 4) Connect the optional external speaker

Connect the Power and Wired Network

To connect the power and wired network:

- 1) Connect the Ethernet cable between the Internet port on the IP phone and PoE port on the PoE adapter.

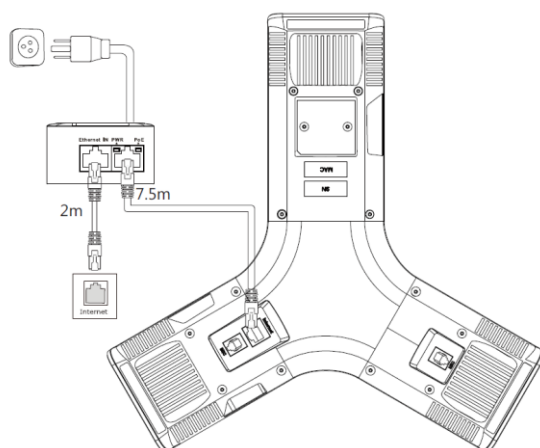

Note The IP phone should be used with Yealink original PoE adapter (54V/0.56A) only. The use of the third-party PoE adapter may cause the damage to the phone. The cable should be replaced at once if its skin is broken.

Important! Do not remove power to the phone while it is updating firmware and configurations.

Connect the Optional PC

To connect a PC:

1. Connect the micro USB port of the IP phone and the USB port of the PC using a micro USB cable.

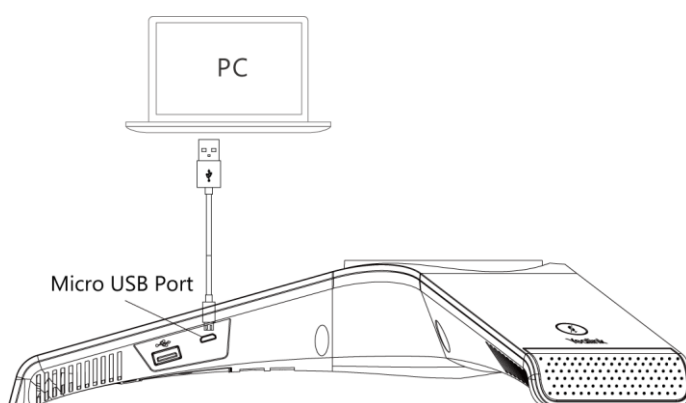

Connect the Optional USB Flash Drive

To connect a USB flash drive:

1. Insert a USB flash drive into the USB port on the phone.

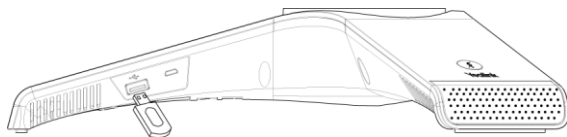

Note

The USB port can also be used to connect CPW90 charging cradle to charge the CPW90. For more information on CPW90, refer to [Using the CP Wireless Expansion Mic CPW90](#) on page 241.

Connect the Optional External Speaker

To connect an optional external speaker:

1. Connect the 3.5mm audio-out port of the IP phone to the external speaker using a 3.5mm jack cable.

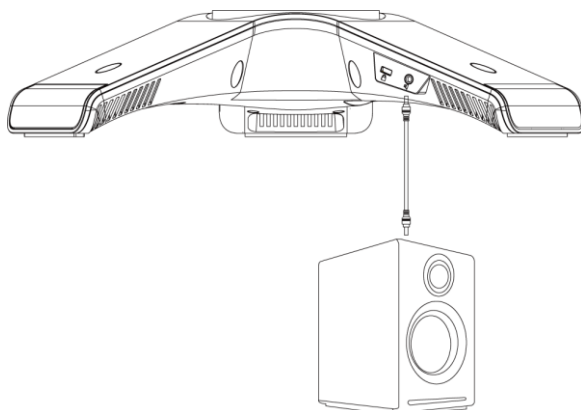

Phone Initialization

After your phone is powered on, the system boots up and performs the following steps:

Automatic Phone Initialization

The phone finishes the initialization by loading the saved configuration. The touch screen displays "Initializing..." during the initialization.

DHCP (Dynamic Host Configuration Protocol)

The phone attempts to contact a DHCP server in your network to obtain valid IPv4 network settings (e.g., IP address, subnet mask, default gateway address and DNS address) by default.

Note If your network does not use DHCP, proceed to [Basic Network Settings](#) on page 46.

Registration

Generally, your phone will be deployed with multiple other phones. In this case, your system administrator will configure the phone parameters beforehand, so that after you start up your phone, the phone will be registered and ready for use. If your phone is not registered, you may have to register it. For more information on how to register your phone, refer to [Account Management](#) on page 113.

Using the Touch Screen

Idle Screen

The CP960 IP phone supports two idle screens. You can swipe left or right to switch between two idle screens.

The Home Screen

The Home screen displays as below:



No.	Name	Description	
1	Status Bar	Displays the label of the current account, icons and time.	
2	Icons	Icons are displayed on the left of the status bar. For more information, refer to Icon Instructions on page 15.	
3	Current Account	The label of the current account is displayed on the middle of the status bar. If there is no account registered on the IP phone, this field will display No Service . If the phone is registered and there is a Bluetooth-Enabled mobile phone connected with the phone, this field will display Multiple account .	
4	Time	The phone's time is displayed on the right of the status bar. For more information, refer to Time & Date on page 68.	
5	Digital Clock	Displays the phone's time and date. For more information, refer to Clock on page 135.	
6	Wallpaper	Shows the specified wallpaper, which can be customized. For more information, refer to Wallpaper on page 58.	
7	System Applications	Settings	Tap to access phone settings and features.
		Browser	Tap to present and explore content on the World Wide Web. For more information, refer to Browser on page 130.
		Message	Tap to access the voice mails or leave voice mails for someone. For more information, refer to Message on page 221.
		History	Tap to enter the History screen and view call history. For more information, refer to Call History Management on page 99.
		Recorder	Tap to record audio. For more information, refer to Recorder on page 124.
8	Screen Indicator	Indicates idle screen you are currently viewing.	
9	Shortcut Keys	Dial	Tap to enter the dialing screen. For more information, refer to Dialing Screen on page 33.
		Directory	Tap to enter the Directory screen and view contacts. For more information, refer to Contact Management on page 82.
		Bluetooth	Tap to enter the Bluetooth settings screen. For more information, refer to Connecting a Mobile Phone Using Bluetooth on page 226.

The DSS Key Screen

The DSS key screen displays phone's line keys. For more information, refer to [Line Keys](#) on page 104.

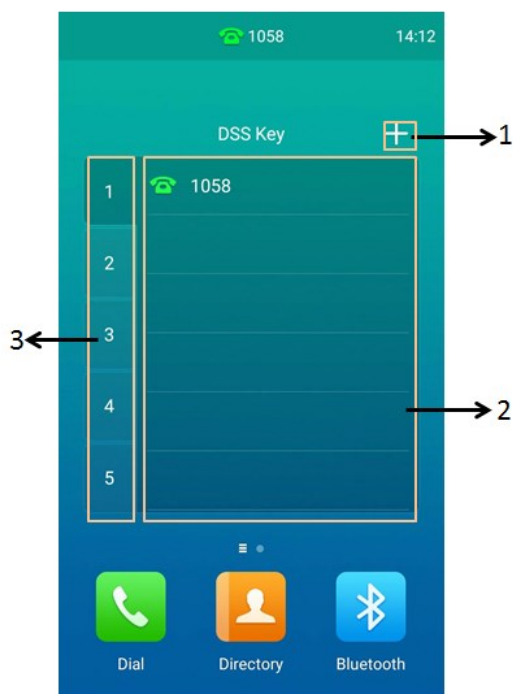





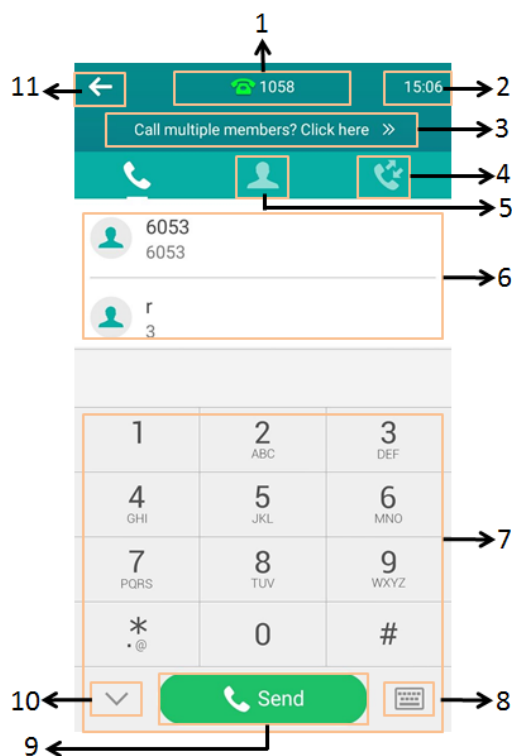

No.	Application	Description
1		Tap to add a line key.
2	Line Key List	This area shows the line key labels. You can customize the line key as other functions.
3	Page Keys	Tap to turn to the corresponding page.

Dialing Screen

You can tap  to access the Dialing screen.



No.	Name	Description
1	Current Account	The label of the current account is displayed on the middle of the status bar. If the phone is registered and there is a Bluetooth-Enabled mobile phone connected with the phone, this field will display Multiple account .
2	Time	The phone's time is displayed on the right of the status bar. For more information, refer to Time & Date on page 68.
3	Call multiple members? Click here >>	Tap to initiate a conference call. For more information, refer to Local Conference on page 162.
4		Tap to enter the History screen and view call history.
5		Tap to enter the Directory screen and view contact information.
6	Placed Calls List	You should enable the recent call in dialing feature to view the placed calls list. For more information, refer to Recent Call In Dialing on

No.	Name	Description
		page 150.
7	Onscreen Dial Pad	Tap to enter the desired number.
8		Tap to display the onscreen keyboard. For more information, refer to Using the Onscreen Keyboard on page 39.
9	Send	Tap to dial out the number.
10		Tap to hide the dial pad. You can tap  to display the dial pad again.
11		Tap to go back to the idle screen.



Calls Screen

The Calls screen is displayed when you have more than one call in progress.

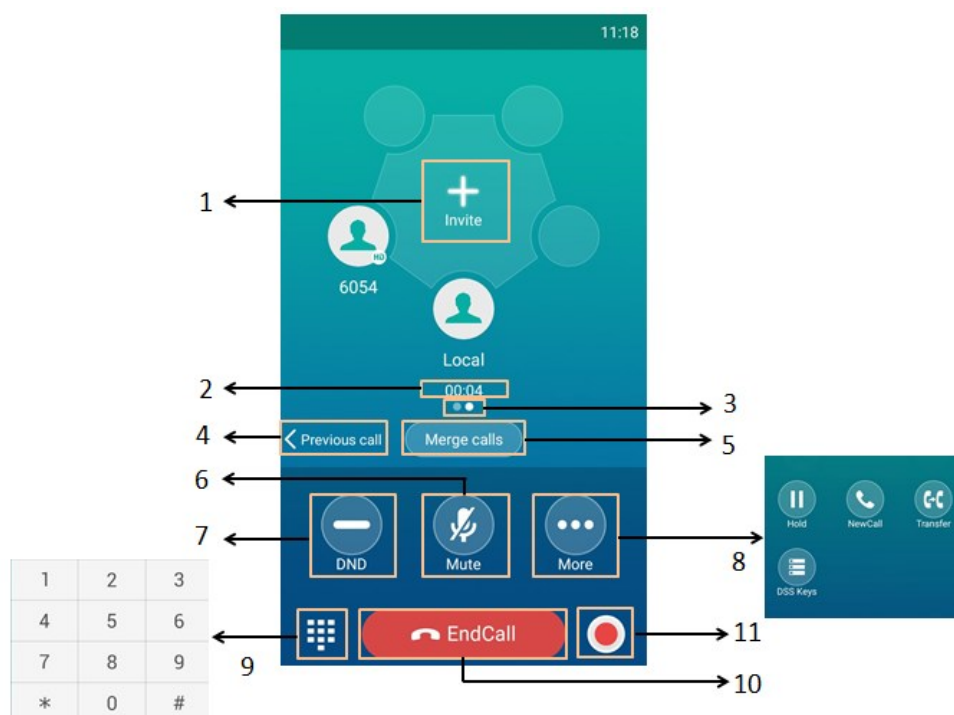
The following shows an example of the Calls screen when there is an active call and a held call on the IP phone:



No.	Name	Description
1	Invite	Tap to invite other party into a conference call. For more information, refer to Local Conference on page 162.
2	Call Duration Timer	Shows the duration time of current call.



No.	Name	Description
3	Screen Indicator	Indicates call screen you are currently viewing.
4	Previous call	Tap to switch to previous call screen.
5	Merge calls	Tap to merge multiple calls into a conference call. For more information, refer to Local Conference on page 162.
6	Mute	Tap to mute the call. For more information, refer to Call Mute/Unmute on page 155.
7	DND	Tap to enable the DND mode. For more information, refer to Rejecting Calls with Do Not Disturb (DND) on page 144.
8	More	Tap to bring up more keys. Hold/Resume: Tap to hold/resume the call. NewCall: Tap to place a new call. Transfer: Tap to transfer the call to another contact. DSS Keys: Tap to access line key list.
9		Tap to bring up the dialpad.
10	EndCall	Tap to end the call.
11		Tap to record the call. For more information, refer to Call and Conference Recording (Local) on page 188.

Configuration Screen

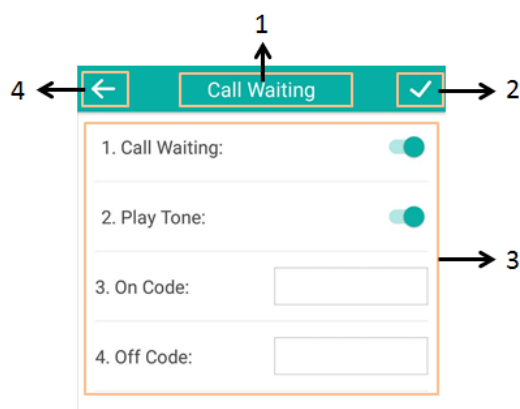
You can tap  to access phone settings and features, and then configure the corresponding settings and features.



No.	Name	Description
1	Title Area	Displays the title of the current menu screen.

No.	Name	Description
2		Tap to accept the settings.
3	Configuration Area	Displays configuration items of the highlighted menu item in the menu tree area. <ul style="list-style-type: none">• Tap the switch button to turn the feature on or off.• Enter the data using the onscreen keyboard.
4		Tap to go back to previous screen.

Control Center/Notification Center

Control center or notification center allows you to access common features or view important notifications quickly.

Note You cannot enter the control center and notification center when calling, ringing or in a call.

Swipe down from the top of the screen to enter the control center and the notification center:

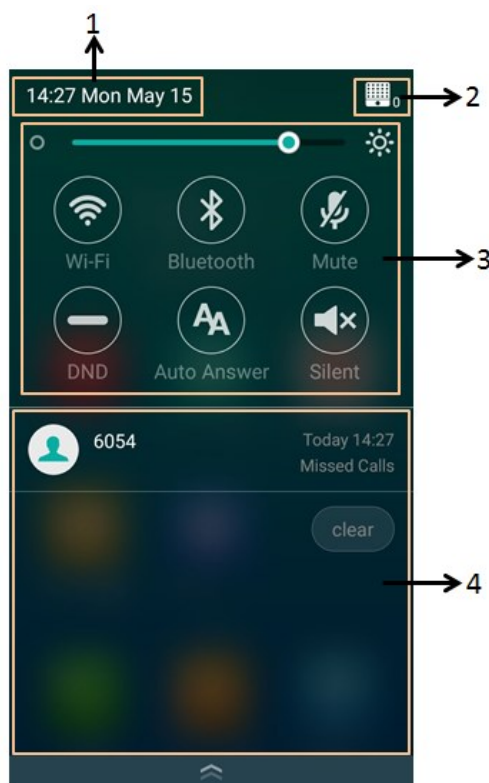

No.	Name	Description
1	Time and date	Display the phone's time and date. For more information, refer to Time & Date on page 68.
2		<ul style="list-style-type: none"> Indicate the number of the connected wireless microphones. Tap to enter the wireless microphone settings screen. For more information, refer to Using the CP Wireless Expansion Mic CPW90 on page 241.
3	Control Center	<p>Backlight Slider</p> <p>Drag the slider to adjust the screen brightness quickly. You can also enter the Backlight setting screen to adjust the screen brightness. For more information, refer to Backlight on page 64.</p> <p>Wi-Fi</p> <ul style="list-style-type: none"> Tap to turn Wi-Fi on or off quickly. For more information, refer to Wireless Network Settings on page 49. Long tap to enter Wi-Fi setting screen.

No.	Name	Description
	Bluetooth	<ul style="list-style-type: none"> • Tap to turn Bluetooth on or off quickly. For more information, refer to Connecting a Mobile Phone Using Bluetooth on page 226. • Long tap to enter Bluetooth setting screen.
	DND	Tap to turn DND on or off quickly. For more information, refer to Rejecting Calls with Do Not Disturb (DND) on page 144.
	Auto Answer	Tap to turn auto answer on or off quickly. For more information, refer to Answer Calls Automatically on page 142.
	Mute	Tap to turn mute on or off quickly. For more information, refer to Call Mute/Unmute on page 155.
	Silent	Tap to turn silent mode on or off quickly. For more information, refer to Silent Mode on page 81.
4	Notification Center	<ul style="list-style-type: none"> • Tap the desired notification message to view the details. • Swipe left or right to delete a specific notification. • Tap clear to delete all notifications.

To exit the control center and the notification center, do one of the following:



- Swipe up from the bottom of the screen.
- Tap the Home touch key.





Navigating Menus and Fields

To navigate menus and fields, you can:

- Tap corresponding keys on the touch screen.
- Tap menu items, fields, and arrows on the touch screen.

To operate your phone using gestures, follow these tips:

Gesture	Action
Tap 	Touch an item on the screen with your finger, and then lift your finger.
Long Tap 	Touch an item for about 2 seconds without lifting your finger from the screen till an action occurs.

Gesture		Action
Swipe		Touch and move. When you want to scroll quickly, swipe your finger across the screen, either up, down, left or right.
Drag		Touch and hold, then move. To stop scrolling, stop the dragging motion.
Pinch Open		Touch the screen with two or more fingers, and then move the fingers away from each other (stretch).
Pinch Close		Touch the screen with two or more fingers, and then move the fingers towards each other (pinch).

Entering Data and Editing Fields

CP960 IP phone provides onscreen keyboard and onscreen dial pad to enter data. Onscreen dial pad provides standard key layout, which enable users to use existing or familiar key positions. You can enter data and edit fields using the onscreen keyboard or onscreen dial pad.

Using the Onscreen Keyboard

Before using the onscreen keyboard to enter data, you need to know the function of the keys on the onscreen keyboard. CP960 IP phone supports two kinds of input methods: Android Keyboard (AOSP) - English (UK) and Google Pinyin. For more information, refer to [Input Method](#) on page 67.

Android Keyboard (AOSP) – English (UK) Input Method

The English (UK) input method supports multiple languages onscreen keyboard. The following takes English keyboard of the English (UK) input method as an example:

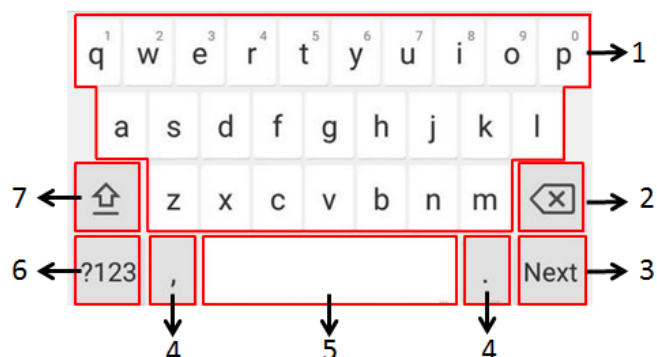

No.	Item	Description	
1	26 English Letters	<ul style="list-style-type: none"> • Tap to enter letters. • Long tap a key then slide to choose one of the options to enter an alternate character. 	
2	Delete Key	<ul style="list-style-type: none"> • Tap to delete the entered characters one by one. • Long tap to delete two or more characters. 	
3	Label automatically to identify the context-sensitive features.	Next Key	Tap to go to the next field.
		Done Key	Tap to confirm the settings.
		Send Key	Tap to dial out the number.
		Go Key	Tap to browse the web page.
4	Two Special Characters	<ul style="list-style-type: none"> • Tap to enter special characters. • Long tap point key (.) then slide to choose one of the options to enter an alternate character. 	
5	Space Key	<ul style="list-style-type: none"> • Tap to enter spaces. • Long tap to change input method. 	
6	?123	Tap to switch to the numeric&symbolic input mode.	
7	⇧	Tap to switch to the uppercase input mode.	

Tap **?123** to switch to the numeric&symbolic input mode as shown below:

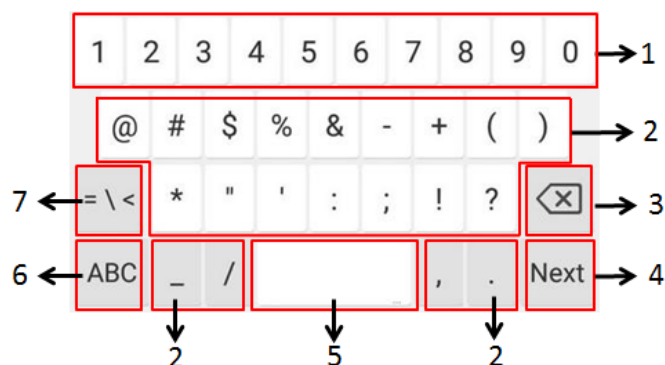

No.	Item	Description	
1	Numbers	<ul style="list-style-type: none"> • Tap to enter numbers. • Long tap a key then slide to choose one of the options to enter an alternate character. 	
2	Special Characters	<ul style="list-style-type: none"> • Tap to enter special characters. • Long tap a key then slide to choose one of the options to enter an alternate character. 	
3	Delete Key	<ul style="list-style-type: none"> • Tap to delete the entered characters one by one. • Long tap to delete two or more characters. 	
4	Label automatically to identify the context-sensitive features.	Next Key	Tap to go to the next field.
		Done Key	Tap to confirm the settings.
		Send Key	Tap to dial out the number.
		Go Key	Tap to browse the web page.
5	Space Key	<ul style="list-style-type: none"> • Tap to enter spaces. • Long tap to change input method. 	
6	ABC	Tap to switch to the lowercase input mode.	
7	= \ <	Tap to switch to the symbolic input mode.	

Tap **~[<** to switch to the symbolic input mode as shown below:

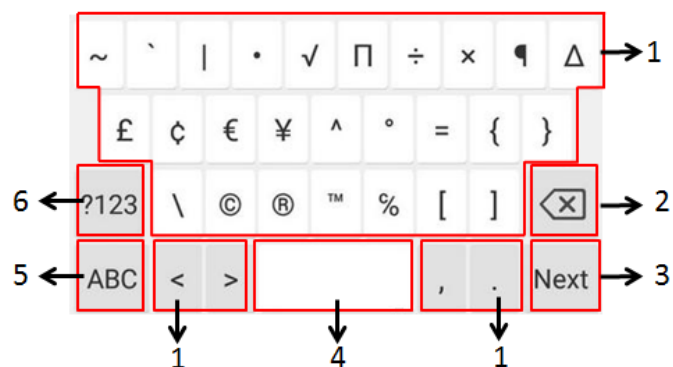

No.	Item		Description
1	Special Characters		<ul style="list-style-type: none"> • Tap to enter special characters. • Long tap a key then slide to choose one of the options to enter an alternate character.
2	Delete Key		<ul style="list-style-type: none"> • Tap to delete the entered characters one by one. • Long tap to delete two or more characters.
3	Label automatically to identify the context-sensitive features.	Next Key	Tap to go to the next field.
		Done Key	Tap to confirm the settings.
		Send Key	Tap to dial out the number.
		Go Key	Tap to browse the web page.
4	Space Key		<ul style="list-style-type: none"> • Tap to enter spaces. • Long tap to change input method.
5	ABC		Tap to switch to the lowercase input mode.
6	?123		Tap to switch to the numeric&symbolic input mode.

Google Pinyin Input Method

You can use Google Pinyin input method to enter Chinese characters. For operating instructions on how to use the Google Pinyin input method, refer to the operating instructions above.



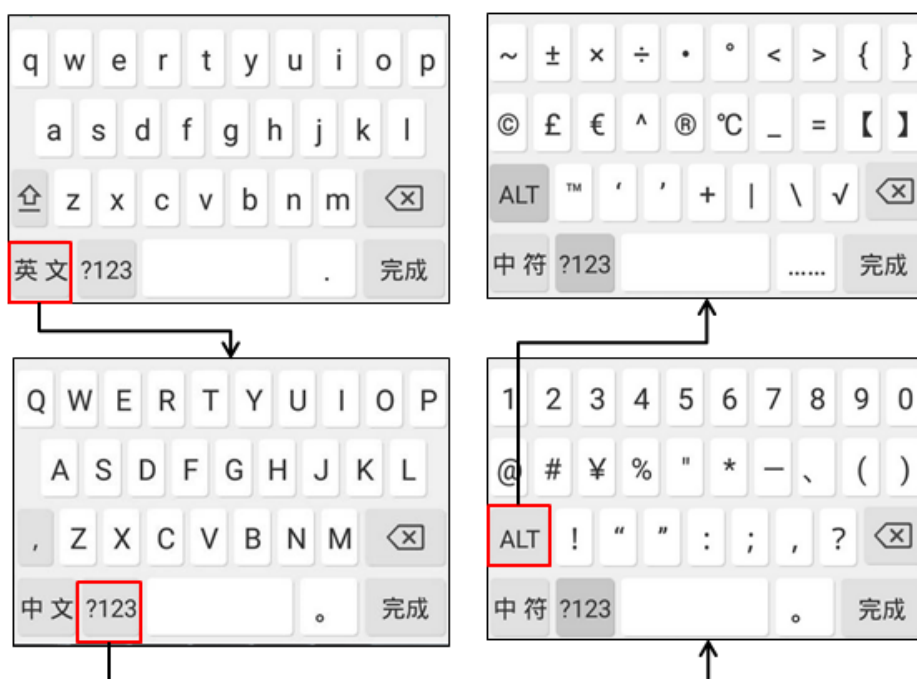

When you change the input method to Google Pinyin, the onscreen keyboard displays the English input mode as shown below by default:







To use onscreen keyboard:

1. Tap the field you want to edit, the onscreen keyboard displays on the touch screen.
2. Enter the information using the onscreen keyboard.
3. Tap **Done** or the blank area of the screen to hide the onscreen keyboard.

The other things you need to know:

If you want to	Action
Position the cursor.	Tap to position.
Select all characters.	<ol style="list-style-type: none"> 1) Long tap the entered character(s). 2) Do one of the following: <ul style="list-style-type: none"> • Tap  on the top of the touch screen. • Drag  to select all characters.
Cut/Copy characters.	<ol style="list-style-type: none"> 1) Long tap the entered character(s). 2) Drag  to select the characters you want to cut/copy. 3) Tap  /  on the top of the touch screen. 4) Long tap the desired field. 5) Tap PASTE.

If you want to	Action
Delete more characters at a time.	<ul style="list-style-type: none"> • Long tap the entered character(s). Drag  /  to select the characters you want to delete. Tap . • Long tap .
Replace characters.	<ol style="list-style-type: none"> 1) Drag your finger to highlight the characters you want to replace. 2) Tap the desired character.

Using the Onscreen Dial Pad

Instead of using the onscreen keyboard, you can also use the dial pad on the dialing screen to enter data. The onscreen dial pad only provide digit keys, # key and * key.

Note When using the onscreen dial pad, you can tap  to display the onscreen keyboard. For more information, refer to [Using the Onscreen Keyboard](#) on page 39.

Phone Status

You can view phone status via phone user interface or web user interface.

Available information of phone status includes:

- General information (IP address, MAC address and firmware version)
- Network status (IPv4 status or IPv6 status, IP mode and MAC address)
 - IPv4 uses a 32-bit address.
 - IPv6 using a 128-bit address which is an updated version of the current Internet Protocol to meet the increased demands for unique IP addresses.
- Phone status (product name, hardware version, firmware version, product ID, MAC address, device certificate status and Android version)
- Account status (register status of SIP accounts)

To view the phone status via phone user interface:

1. Tap **Settings** from the Home screen.

2. Tap **General** from the **Status** block.

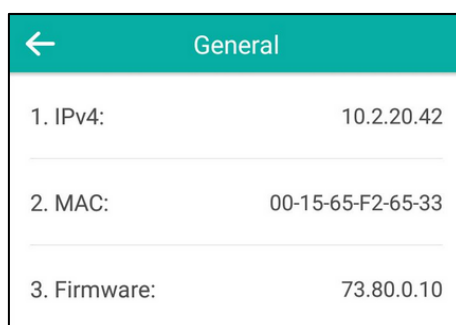

Note You can view the device certificate status via phone user interface only.

To view the phone status via web user interface:

1. Open a web browser on your computer.
2. Enter the IP address in the browser's address bar, and then press the **Enter** key.
(e.g., "http://192.168.0.10" for IPv4 or "http://[2005:1:1:1:215:65ff:fe64:6e0a]" for IPv6).
3. Enter the user name (admin) and password (admin) in the login page.

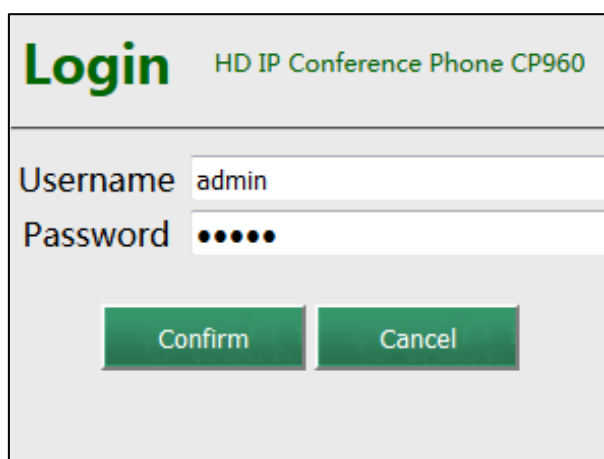

4. Click **Confirm** to login.

The phone status is displayed on the first page of the web user interface.

Section	Item	Value
Version	Firmware Version	73.80.0.10
	Hardware Version	73.0.0.9.0.0.0
Network	Internet Port	IPv4
IPv4	WAN Port Type	DHCP
	WAN IP Address	10.2.20.42
	Subnet Mask	255.255.255.0
	Gateway	10.2.20.254
	Primary DNS	192.168.1.20
	Secondary DNS	192.168.1.22
	Network Common	MAC Address
Link Status		Connected
Device Type		Bridge
Account Status	Account1	1058@10.2.1.48 : Registered

NOTE

Version
It shows the version of firmware.

Network
It shows the information of WAN port.

You can click here to get more guides.

Note If IP mode of the phone is configured as **IPv4 & IPv6**, you can enter either of them in the browser's address bar to view the phone status. IPv6 is not available on all servers. Contact your system administrator for more information.

Basic Network Settings



If your phone cannot contact a DHCP server for any reason, you need to configure network settings manually. The IP phone can support either or both IPv4 and IPv6 addresses.

To configure the IP mode via phone user interface:

1. Tap **Settings** from the Home screen.
2. Enter the admin password (default password: admin) from the **Advanced** block.
3. Tap **Network**->**WAN Port**.
4. Tap the **IP Mode** field.

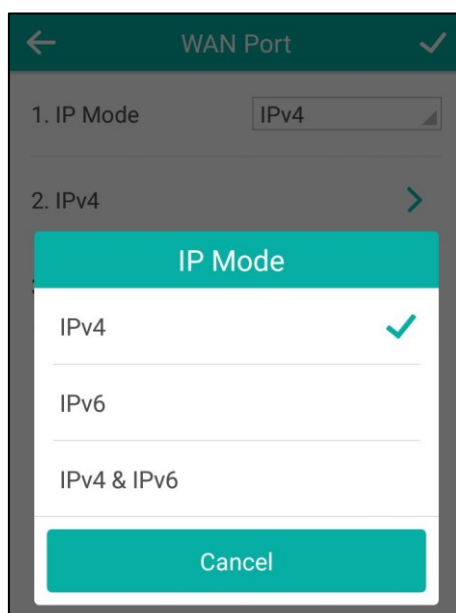
- Tap the desired value (**IPv4**, **IPv6** or **IPv4 & IPv6**) in the pop-up dialog box.



- Tap  to accept the change or  to cancel.

You can configure a static IPv4 address for the IP phone. Before configuring it, make sure that the IP mode is configured as **IPv4** or **IPv4 & IPv6**.

To configure a static IPv4 address via phone user interface:

- Tap **Settings** from the Home screen.
- Enter the admin password (default password: admin) from the **Advanced** block.
- Tap **Network**->**WAN Port**->**IPv4**.
- Tap the **Type** field.
- Tap **Static IP** in the pop-up dialog box.
- Enter the desired value in the **IP Address**, **Subnet Mask**, **Gateway**, **Primary DNS** and **Secondary DNS** field respectively.

 A screenshot of a mobile application interface for configuring a static IPv4 address. The header bar is teal and contains a back arrow, the text "IPv4 WAN Port", and a checkmark. The main content area has six numbered fields:

- Type:** A dropdown menu set to "Static IP".
- IP Address:** A text input field containing "192.168.1.20".
- Subnet Mask:** A text input field containing "255.255.255.0".
- Gateway:** A text input field containing "192.168.1.254".
- Primary DNS:** A text input field containing "202.101.103.55".
- Secondary DNS:** A text input field containing "202.101.103.56".

7. Tap ✓ to accept the change or ← to cancel.

You can configure a static IPv6 address for the IP phone. Before configuring it, make sure that the IP mode is configured as **IPv6** or **IPv4 & IPv6**.

To configure a static IPv6 address via phone user interface:

1. Tap **Settings** from the Home screen.
2. Enter the admin password (default password: admin) from the **Advanced** block.
3. Tap **Network**->**WAN Port**->**IPv6**.
4. Tap the **Type** field.
5. Tap **Static IP** in the pop-up dialog box.
6. Enter the desired value in the **IP Address**, **IPv6 IP Prefix**, **Gateway**, **Primary DNS** and **Secondary DNS** field respectively.

IPv6 WAN Port	
1. Type:	Static IP
2. IP Address:	2005:1:1:1::12
3. IPv6 IP Prefix:	64
4. Gateway:	2005:1:1:1::1
5. Primary DNS:	2005:1:1:1::88
6. Secondary DNS:	2005:1:1:1::89

7. Tap ✓ to accept the change or ← to cancel.

If you are using an xDSL modem for IPv4 network connection, you can connect your phone to the Internet via PPPoE mode. Set the WAN port as a PPPoE port. The PPPoE port will perform a PPP negotiation to obtain the IP address. Contact your system administrator for the PPPoE user name and password.

To configure PPPoE via phone user interface:

1. Tap **Settings** from the Home screen.
2. Enter the admin password (default password: admin) from the **Advanced** block.
3. Tap **Network**->**WAN Port**->**IPv4**.
4. Tap the **Type** field.
5. Tap **PPPoE** in the pop-up dialog box.

6. Enter the PPPoE user name and password in the corresponding fields.

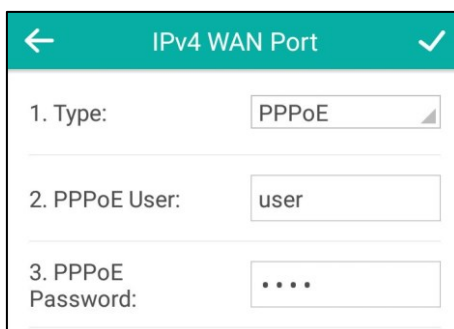

7. Tap ✓ to accept the change or ← to cancel.

Note

The wrong network settings may result in inaccessibility of your phone and may also have an impact on your network performance. For more information on these parameters, contact your system administrator.

Wireless Network Settings

Yealink CP960 IP phone supports Wi-Fi feature. The IP phone can be connected to wireless network if Wi-Fi is available within the area. For more information, contact your system administrator.

Note

Enabling Bluetooth may degrade your wireless network connection. To improve wireless network performance, you should disable Bluetooth when it is not in use. For more information, refer to [Activating/Deactivating the Bluetooth Mode](#) on page 226.

Connecting to the Wireless Network

Three ways to connect CP960 IP phone to the wireless network:

- Manually connect to an available wireless network
- Wi-Fi Protected Setup (WPS)
- Manually add a wireless network

When the phone is connected to a wireless network, the Wi-Fi icon  will display on the status bar. The Wi-Fi icon indicates the signal strength. The more green arcs you see, the stronger the signal strength is. For more information, refer to [Icon Instructions](#) on page 15. And the Wi-Fi label in the control center will change to the SSID of the connected wireless network.

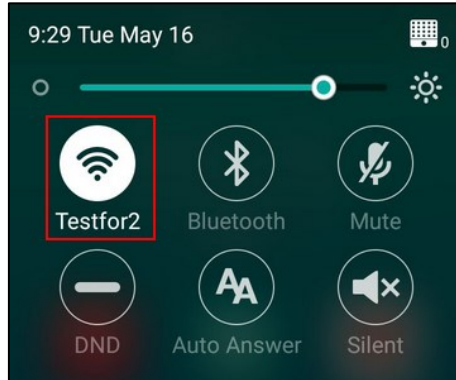

Manually Connect to an Available Wireless Network

You can manually connect your phone to a wireless network.

To manually connect to an available wireless network via phone user interface:

1. Tap **Settings** from the Home screen.
 2. Tap **Wi-Fi** from the **Basic** block.
 3. Turn on **Wi-Fi**.
- The phone will automatically search for available wireless networks in your area.
4. (Optional.) To re-search the available network, tap  and then tap **Scan**.
 5. Tap the desired wireless network (SSID) to connect.
 6. If the network is secure, enter its password in the **Password** field.

Contact your network administrator for the Wi-Fi password.

You can do the following:

- Tap the **Show password** radio box to make the password visible.

- Tap the **Show advanced options** radio box to configure the HTTP proxy for **Browser** application.

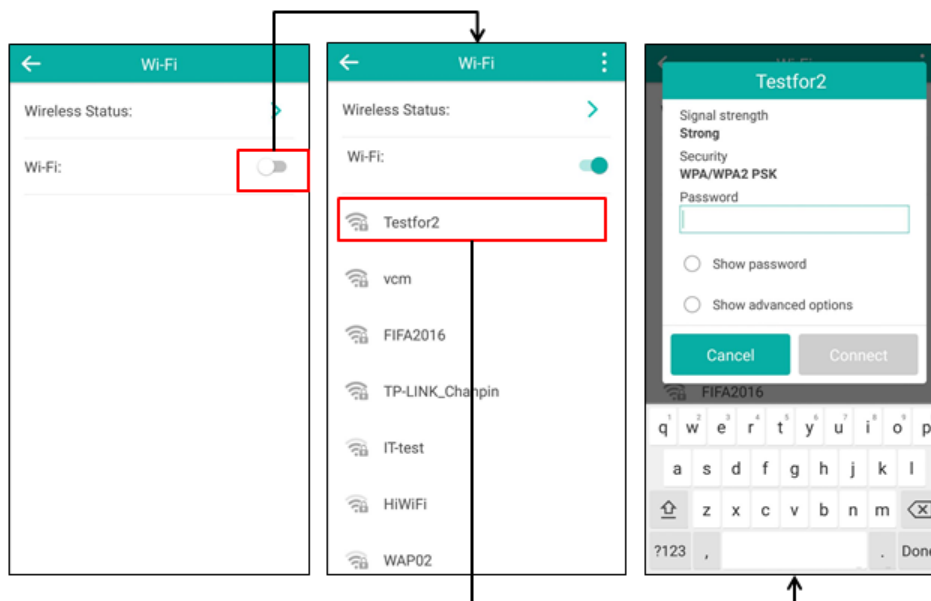

7. Tap **Connect** to connect to the wireless network.

Once the connection is established successfully, the prompt "Connected" appears under the corresponding SSID.

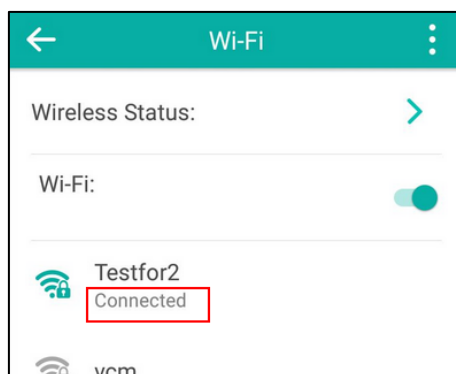

You can also swipe down from the top of the screen to enter the control center, and toggle **Wi-Fi** on. The phone will automatically search for wireless network in your area, and try to connect the wireless network that you have connected last time. If there are no available wireless networks or the phone cannot connect the wireless network that you have connected last time, you will get a notification "  Wi-Fi networks available". You can tap the notification, and then repeat steps 4 to 7 to connect to the desired wireless network.

Wi-Fi Protected Setup (WPS)

Wi-Fi Protected Setup (WPS) provides simplified mechanisms to configure secure wireless networks. WPS can automatically configure a wireless network with a network name (SSID) and strong WPA data encryption and authentication.

Two methods supported by Yealink IP phones in the Wi-Fi protected setup:

- Push Button Configuration (PBC): The user simply has to push the WPS key on both the IP phone and gateway/router to connect.
- Personal Identification Number (PIN): The user has to enter a WPS PIN generated randomly by the IP phone on the gateway/router to connect.

Push Button Configuration (PBC)

To connect to the wireless network using PBC method:

1. Tap **Settings** from the Home screen.
2. Tap **Wi-Fi** from the **Basic** block.
3. Turn on **Wi-Fi**.

The phone will automatically search for available wireless networks in your area.

4. Tap  and then tap **WPS**.

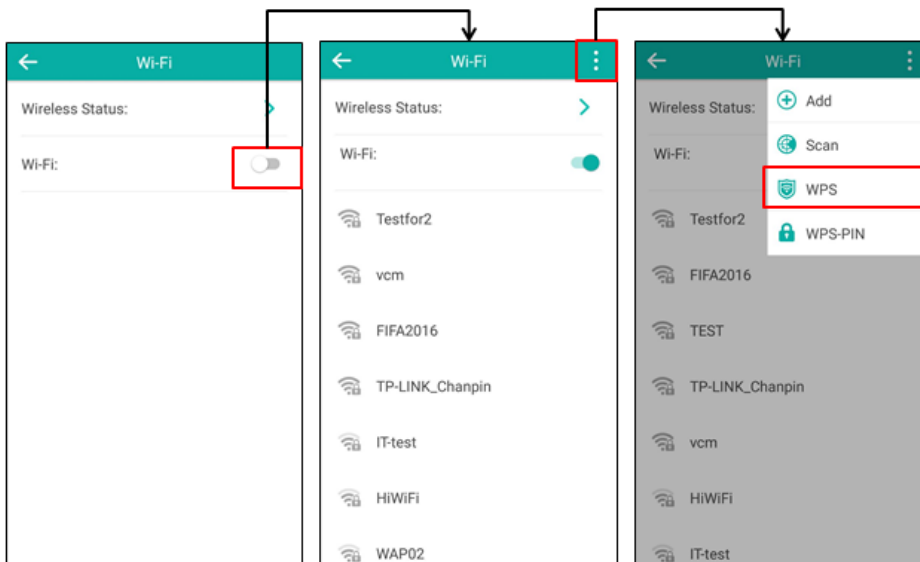

The touch screen prompts "Press the Wi-Fi Protected Setup button on your router. It may be called "WPS" or contain this symbol:".

5. Long press the WPS key on your gateway/router.

Once WPS setup is established successfully, the touch screen will prompt "Connected".

Personal Identification Number (PIN)

To connect to the wireless network using PIN method:

1. Tap **Settings** from the Home screen.
2. Tap **Wi-Fi** from the **Basic** block.
3. Turn on **Wi-Fi**.

The phone will automatically search for available wireless networks in your area.

4. Tap  and then tap **WPS-PIN**.

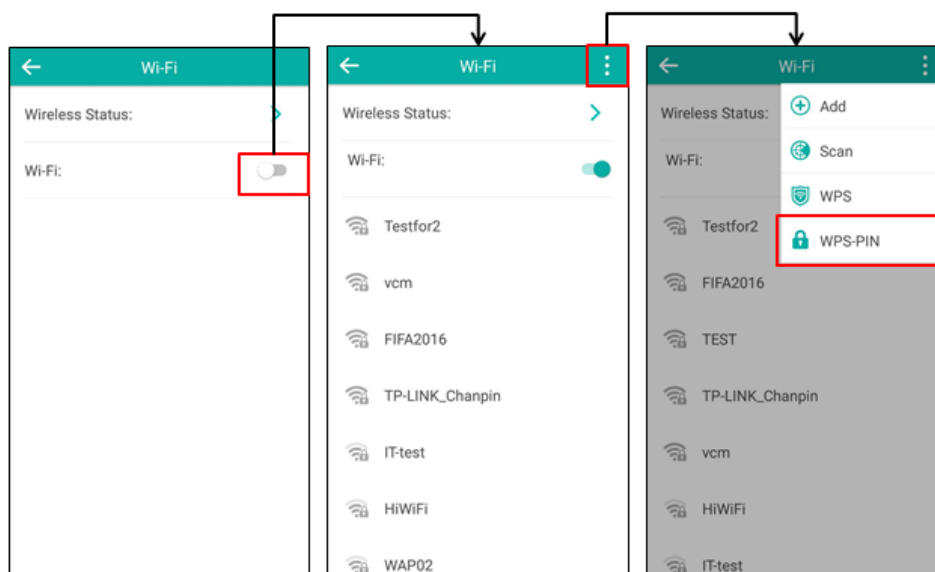

The touch screen prompts "Enter pin XXX on your Wi-Fi router. The setup can take up to two minutes to complete.". Note the PIN code.

5. Log into the gateway/router management interface on your PC.
6. Locate the **WPS Wizard** configuration menu.
7. Enter the PIN code in the field that allows you to setup wireless devices by a PIN.
8. Click the corresponding button in the gateway/router's web interface to search WPS clients.

Once WPS setup is established successfully, the touch screen will prompt "Connected".

Note Contact your gateway/router provider for more information.

Manually Add a Wireless Network

If your gateway/router has SSID broadcast disabled, it might not appear in the scanning results. In that case, you must manually add a wireless network.

To add a wireless network:

1. Tap **Settings** from the Home screen.
2. Tap **Wi-Fi** from the **Basic** block.
3. Turn on **Wi-Fi**.

4. Tap  and then tap **Add**.
5. Enter the desired value in the **Network SSID** field.
6. Tap the **Security** field.

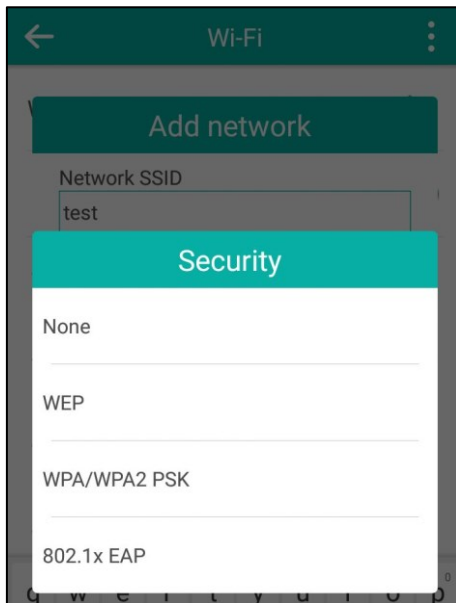

7. Tap the desired value.
 - If you select **WEP** or **WPA/WPA2 PSK**:
 - 1) Enter the password in the **Password** field.
 - If you select **802.1x EAP**:
 - 1) Tap the **EAP method** field.
 - 2) Tap the desired EAP method in the pop-up dialog box.
 - If you select **PEAP/TTLS**:
 - a) Tap the Phase-2 authentication field.
 - b) Tap the desired Phase-2 authentication method in the pop-up dialog box.
 - c) Enter the identity (username) in the **Identity** field.
 - d) Enter the anonymous identity (username) in the **Anonymous identity** field (to be used as the unencrypted identity).
 - e) Enter the password in the **Password** field.
 - If you select **TLS**:
 - a) Enter the username in the **Identity** field.
 - If you select **PWD**:
 - a) Enter the username in the **Identity** field.
 - b) Enter the password in the **Password** field.

8. You can do the following:
 - Tap the **Show password** radio box to make the password visible.
 - Tap the **Show advanced options** radio box to configure the HTTP proxy for **Browser** application.
9. Tap **Save** to accept the change.

Viewing the Connected Wireless Network Information

To view the connected wireless network information:

1. Tap **Settings** from the Home screen.
2. Tap **Wi-Fi** from the **Basic** block.
3. Tap **Wireless Status** to view the detailed information of the connected wireless network (e.g., Profile Name, SSID or Signal Strength).

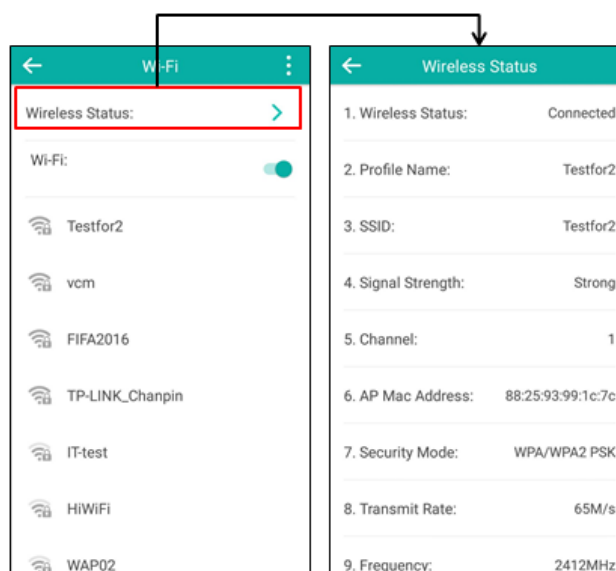

Disconnecting the Wireless Network

You can disconnect the wireless network from your phone.

To disconnect the wireless network:

1. Tap **Settings** from the Home screen.
2. Tap **Wi-Fi** from the **Basic** block.

3. Tap the connected SSID (the top one).

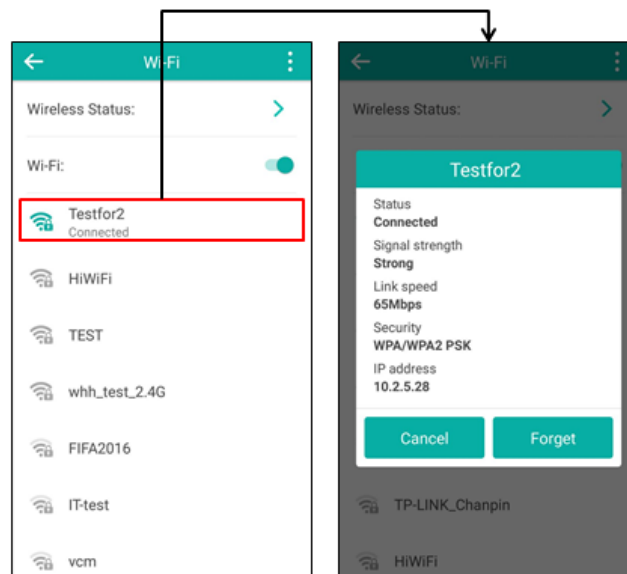

4. Tap **Forget**.

Disabling Wi-Fi Feature

To disable Wi-Fi feature, do one of the following:

- Tap **Settings** from the Home screen.
Tap **Wi-Fi** from the **Basic** block.
Turn off **Wi-Fi**.

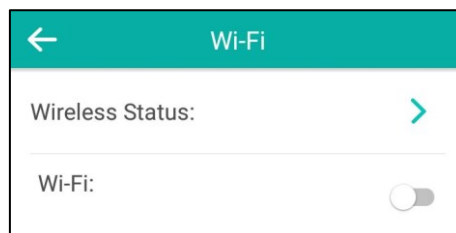

- Swipe down from the top of the screen to enter the control center, and then toggle Wi-Fi off.

The Wi-Fi icon disappears from the status bar, and the Wi-Fi label resumes to Wi-Fi.

Customizing Your Phone

You can customize your CP960 IP phone by personally configuring certain settings, for example, wallpaper, time & date and ring tones. You can add contacts to the phone's local directory manually or from call history. You can also personalize different ring tones for different callers.

This chapter provides basic operating instructions for customizing your phone. Topics include:

- [General Settings](#)
- [Audio Settings](#)
- [Contact Management](#)
- [Call History Management](#)
- [Search Source List in Dialing](#)
- [System Customizations](#)

If you require additional information or assistance with your new phone, contact your system administrator.

General Settings

Wallpaper

You can customize the wallpaper of the CP960 IP phone and can change the wallpaper image via phone user interface or web user interface. You can also upload custom pictures as wallpaper images via web user interface.

The CP960 IP phone supports the wallpaper images in *.jpg/*.png/*.bmp/*.jpeg format.

Uploading the Custom Wallpaper

To upload the custom wallpaper via web user interface:

1. Click on **Settings->Preference**.

- In the **Upload Wallpaper** field, click **Browse** to locate and upload the picture from your local system.

The screenshot displays the Yealink CP960 web interface. The top navigation bar includes 'Status', 'Account', 'Network', 'DSSKey', 'Features', 'Settings', 'Directory', and 'Security'. The left sidebar lists various configuration categories. The main settings area shows a list of parameters with their current values and controls. The 'Upload Wallpaper' field is highlighted with a red rectangular box, showing 'No selected file' and a 'Browse...' button. Below this field are 'Upload' and 'Cancel' buttons. At the bottom of the settings area are 'Confirm' and 'Cancel' buttons. A 'NOTE' section on the right states: 'Preference Settings: The preference settings for administrator. You can click here to get more guides.'

- Click **Upload** to upload the file.

The uploaded custom picture appears in the pull-down lists of **Wallpaper**. You can only delete the custom wallpaper by clicking **Del** when selecting the desired custom wallpaper in the **Wallpaper** field.

Changing the Wallpaper

To change the wallpaper via phone user interface:

- Tap **Settings** from the Home screen.
- Tap **Display** from the **Basic** block.
- Tap **Wallpaper**.

The touch screen displays the current used wallpaper in the background and built-in wallpapers on the bottom of the touch screen.



4. Select a desired wallpaper from the built-in wallpapers list.
5. Tap **Set wallpaper**.

Wallpaper is configurable via web user interface at the path **Settings->Preference**.

Note The CP960 IP phone screen size is 5 inches (Resolution: 720x1280). If the size of the custom picture doesn't meet the IP phone screen size, the wallpaper will be stretched or/and zoomed out according to the screen size.

Screen Saver

The screen saver will automatically start each time your phone is idle for a certain amount of time. The screen saver is used to blank the screen or fill it with moving images or patterns.

The screen saver will be stopped when:

- Tap any touch key.
- Tap the touch screen.
- There is an incoming call.
- A new prompt (e.g., missed call, new voice mail or forwarded call).
- The status of BLF key changes.

If your phone is idle again for a specified period of time, the screen saver will start again.

The CP960 IP phone supports four screen saver types: Clock, Colors, Photo Frame and Photo Table.

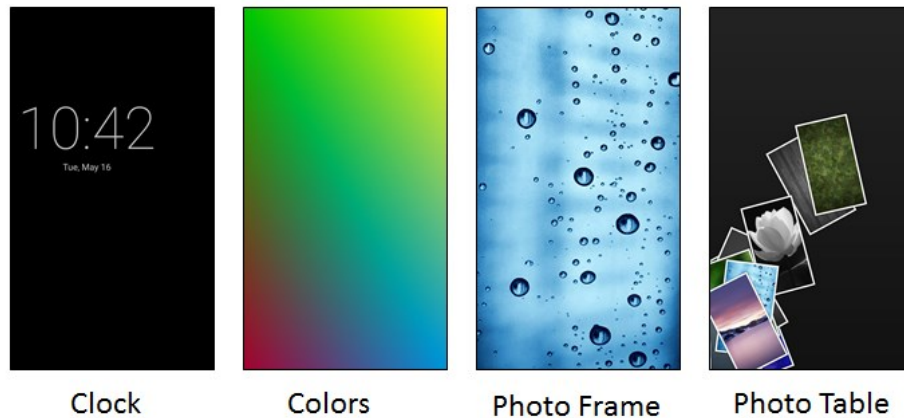

The following shows the touch screen displays in different screen saver types:

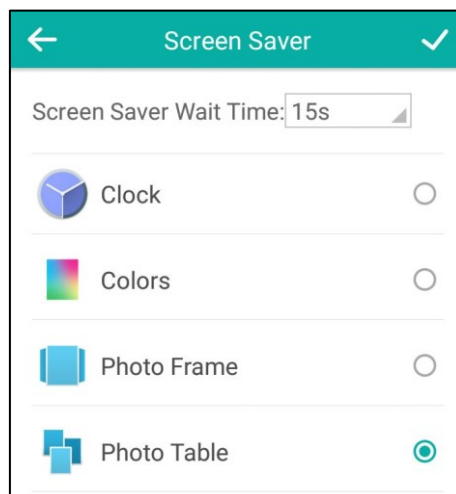

To configure the screen saver via phone user interface:

1. Tap **Settings** from the Home screen.
2. Tap **Display** from the **Basic** block.
3. Tap **Screen Saver**.
4. Tap the **Screen Saver Wait Time** field.
5. Tap the desired time in the pop-up dialog box.
6. Tap the radio box after desired screen saver type.



7. Tap  to accept the change or  to cancel.

Note

Screen saver is configurable via phone user interface only.

Power Saving

The power saving feature is used to turn off the backlight and screen to conserve energy. The IP phone enters power-saving mode after it has been idle for a certain period of time.

The IP phone will exit power-saving mode when:

- Tap any touch key.
- Tap the touch screen.
- There is an incoming call.
- A new prompt (e.g., missed call, new voice mail or forwarded call).
- The status of BLF key changes.

If the screen saver is enabled on your phone, power-saving mode will still occur.

You can configure the following power-saving settings:

- Office Hour
- Idle TimeOut (minutes)

Note Power saving is configurable via web user interface only.

Configuring the Office Hour

Office Hour specifies the starting time and ending time in the office each day.

To configure the office hour via web user interface:

1. Click on **Settings->Power Saving**.
2. Select a desired day of the week.
3. Enter the starting time and ending time respectively in the desired day field.

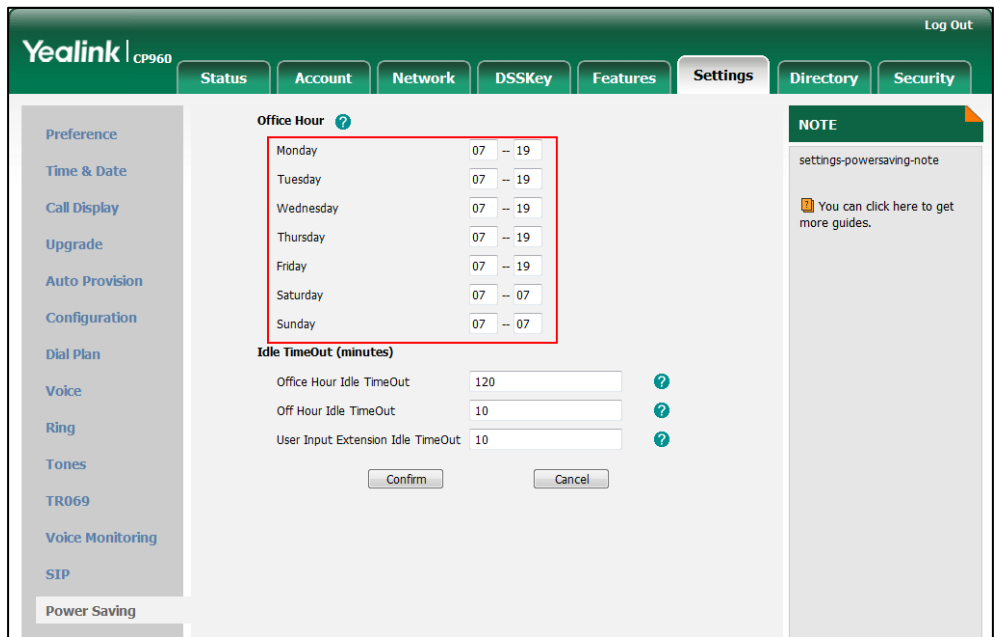

4. Click **Confirm** to accept the change.

Configuring the Idle TimeOut

Idle TimeOut specifies the period of time before the IP phone enters power-saving mode. The following three types of idle timeout you can configure:

- **Office Hour Idle TimeOut:** Configures the idle timeout for office hours.
- **Off Hour Idle TimeOut:** Configures the idle timeout for non-office hours.
- **User Input Extension Idle TimeOut:** Configures the idle timeout that applies after you use the IP phone (for example, tap Mute touch key on the phone or tap the touch screen).

By default, the Office Hour Idle TimeOut is much longer than the Off Hour Idle TimeOut. If you use the IP phone, the idle timeout that applies (User Input Extension Idle TimeOut or Office Hour/Off Hour Idle TimeOut) is the timeout with the highest value. If the phone has an incoming call or message, the User Input Extension Idle TimeOut will be ignored.

To configure the idle timeout via web user interface:

1. Click on **Settings->Power Saving**.
2. Enter the desired value in the **Office Hour Idle TimeOut** field.
The default value is 120, you can set to 1-240.
3. Enter the desired value in the **Off Hour Idle TimeOut** field.
The default value is 10, you can set to 1-10.
4. Enter the desired value in the **User Input Extension Idle TimeOut** field.
The default value is 10, you can set to 1-30.

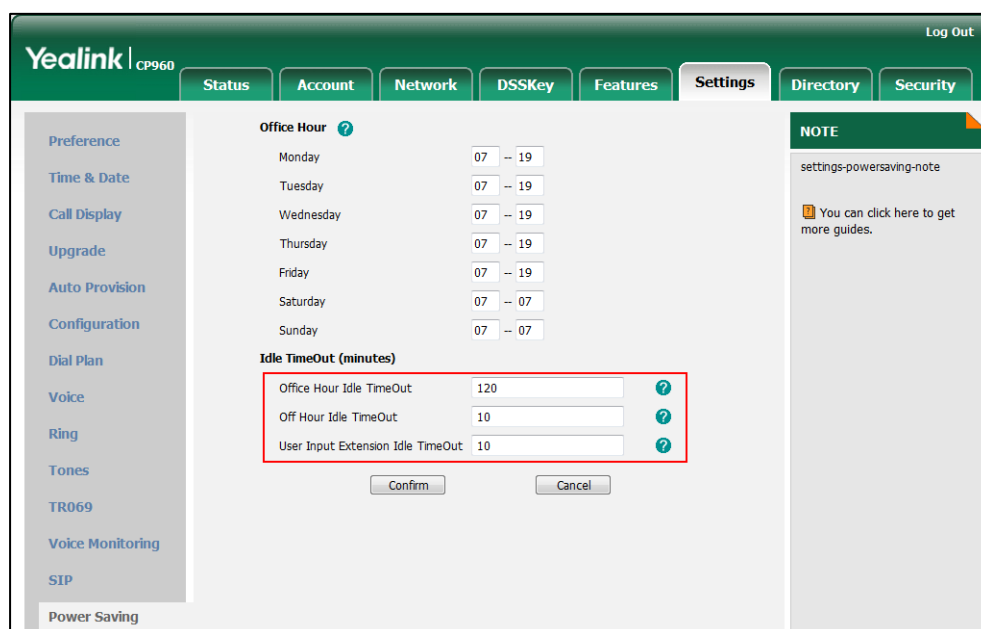

5. Click **Confirm** to accept the change.

Backlight

Backlight has two options:

Backlight Active Level: The intensity of the touch screen when the phone is active.



Backlight Time: The delay time to change the intensity of the touch screen when the phone is inactive. You can select a desired time to change the intensity or turn on the backlight permanently.

- **Always On:** Backlight is on permanently.
- **15s, 30s, 60s, 120s, 300s, 600s or 1800s:** Backlight is changed when the phone is inactive after the designated time (in seconds).

To configure the backlight via phone user interface:

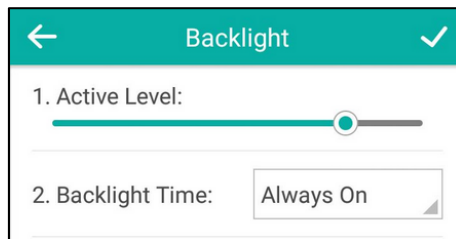
1. Tap **Settings** from the Home screen.
2. Tap **Display** from the **Basic** block.
3. Tap **Backlight**.
4. Drag the **Active Level** slider to change the intensity of the touch screen.
5. Tap the **Backlight Time** field.
6. Tap the desired time in the pop-up dialog box.



7. Tap  to accept the change or  to cancel.

You can also drag the backlight slider on the control center to change the intensity of the touch screen.

To configure the backlight active level on the control center:

1. Swipe down from the top of the screen to enter the control center.

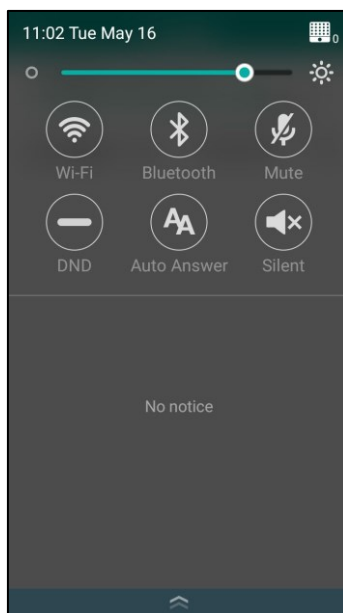

2. You can do one of the following:

- Drag the backlight slider.

When dragging the slider, the control center (except the backlight slider) and notification center will be hidden. You can view the intensity changes of the touch screen in real-time.



If you lift your finger, the control center and notification center will be shown again.

- Tap .

The intensity of the touch screen is changed to the highest.

- Tap .

The intensity of the touch screen is changed to the lowest.

Backlight is configurable via web user interface at the path **Settings->Preference**.



Language

The default language of the phone user interface is English. If the language of your web browser is not supported by the phone, the web user interface will use English by default. You can change the language for the phone user interface and the web user interface respectively.

To change the language for the phone user interface:

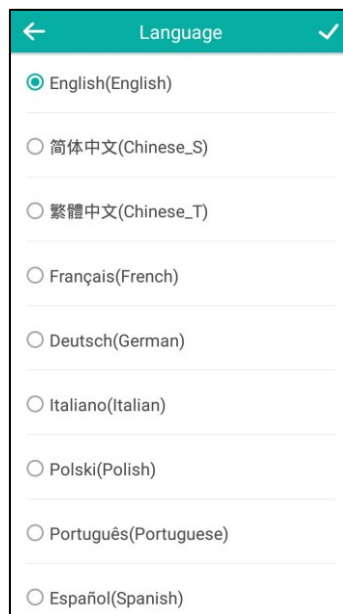
1. Tap **Settings** from the Home screen.
2. Tap **Language & Input** from the **Basic** block.
3. Tap **Language**.
4. Drag up and down to scroll through the list of available languages.
5. Tap the desired language.



6. Tap  to accept the change or  to cancel.

Text displayed on the phone user interface will change to the selected language.

To change the language for the web user interface:

1. Click on **Settings->Preference**.

2. Select the desired language from the pull-down list of **Language**.

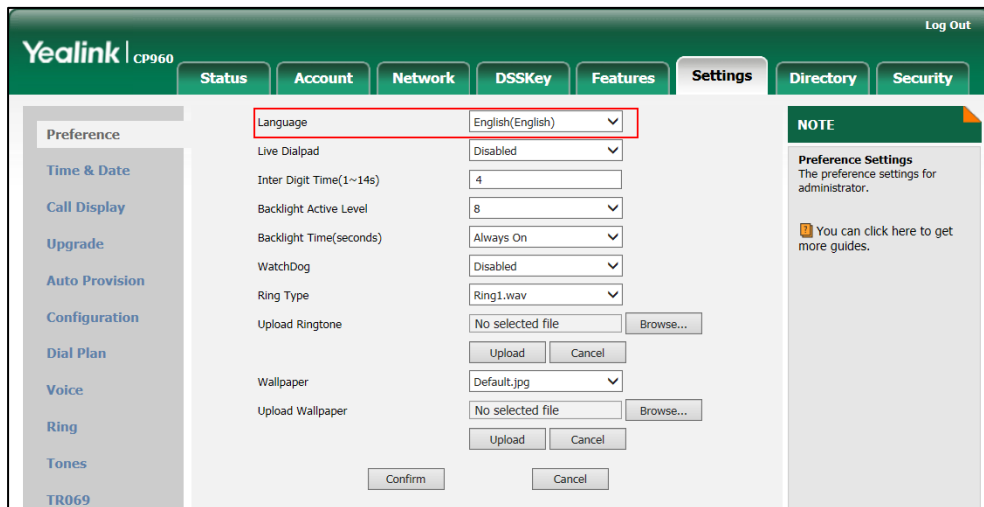

3. Click **Confirm** to accept the change.

Text displayed on the web user interface will change to the selected language.

Input Method

CP960 IP phone supports two kinds of input methods: Android Keyboard (AOSP) - English (UK) and Google Pinyin. The default input method is English (UK). You can change the current used input method.

To change the input method:

1. Tap **Settings** from the Home screen.
2. Tap **Language & Input** from the Basic block.
3. Tap **Current Input**.
4. Tap the desired input method in the pop-up dialog.

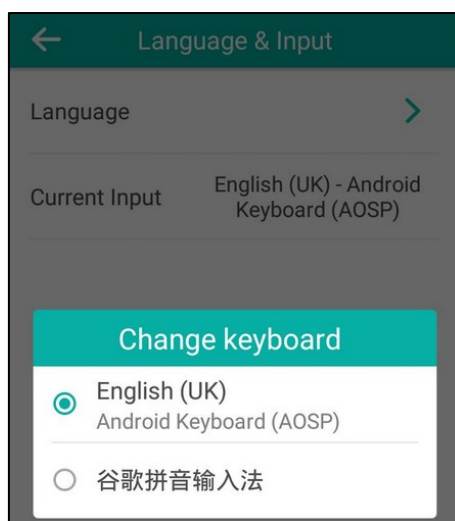

You can also long tap the space key on the onscreen keyboard to change the input method:

The following takes Android Keyboard (AOSP) - English (UK) input method as example:

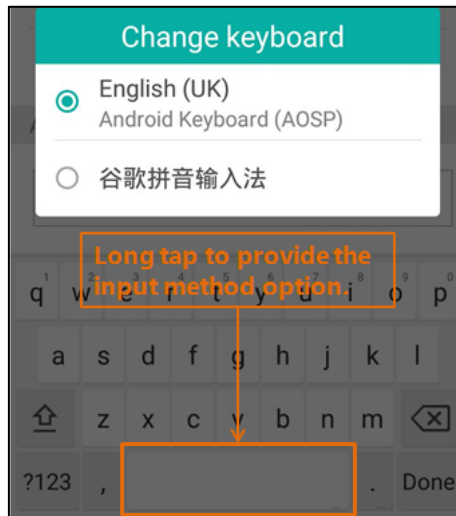

Note Input method is configurable via phone user interface only.

Time & Date

There are three ways to view the time and date via phone user interface:

- Viewing phone's time on the status bar.
- Viewing phone's time and date by digital clock (refer to [Clock](#)).
- Viewing phone's time and date in the control center.

You can configure the phone to obtain the time and date from the SNTP server automatically, or configure the time and date manually. If the phone cannot obtain the time and date from the Simple Network Time Protocol (SNTP) server, contact your system administrator for more information.

To configure the SNTP setting via phone user interface:

1. Tap **Settings** from the Home screen.
2. Tap **Time & Date** from the **Basic** block.
3. Tap **General**.
4. Tap the **Type** field.
5. Tap **SNTP Settings** in the pop-up dialog box.
6. Tap the **Time Zone** field.
7. Tap the time zone that applies to your area in the pop-up dialog box.
The default time zone is "+8".
8. Enter the domain name or IP address of SNTP server in the **NTP Server1** and **NTP Server2** field respectively.

9. Tap the **Daylight Saving** field.
10. Tap the desired value in the pop-up dialog box.
11. Tap the **Location** field.
This field appears only if **Daylight Saving** field is selected to **Automatic**.
12. Tap the desired time zone name in the pop-up dialog box.
The default time zone name is "China(Beijing)".

The screenshot shows the 'General' settings screen with the following fields:

1. Type:	SNTP Settings
2. Time Zone:	+8
3. NTP Server1:	cn.pool.ntp.org
4. NTP Server2:	pool.ntp.org
5. Daylight Saving:	Automatic
6. Location:	China(Beijing)

13. Tap to accept the change or to cancel.

Note



Please refer to [Appendix A - Time Zones](#) for the list of available time zones on the IP phone.

To configure the time and date manually via phone user interface:

1. Tap **Settings** from the Home screen.
2. Tap **Time & Date** from the **Basic** block.
3. Tap **General**.
4. Tap the **Type** field.
5. Tap **Manual Settings** in the pop-up dialog box.
6. Enter the specific date and time in the corresponding fields.

The screenshot shows the 'General' settings screen with the following fields:

1. Type:	Manual Settin...
2. Date:	2017 - 05 - 16
3. Time:	11 - 31 - 00

7. Tap  to accept the change or  to cancel.

The time and date displayed on the touch screen will change accordingly.

You can also configure the date format for the time and date that displays on the control center. There are 7 available date formats. For example, for the date format “WWW DD MMM”, “WWW” denotes the abbreviation of the weekday, “DD” denotes the two-digit day, and “MMM” denotes the first three letters of the month.



The date formats available:

Date Format	Example (2017-05-16)
WWW MMM DD	Tue May 16
DD-MMM-YY	16-May-17
YYYY-MM-DD	2017-05-16
DD/MM/YYYY	16/05/2017
MM/DD/YY	05/16/17
DD MMM YYYY	16 May 2017
WWW DD MMM	Tue 16 May

To configure the date and time format via phone user interface:

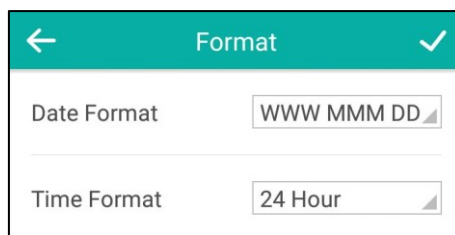
1. Tap **Settings** from the Home screen.
2. Tap **Time & Date** from the **Basic** block.
3. Tap **Time & Date Format**.
4. Tap the **Date Format** field.
5. Tap the desired date format in the pop-up dialog box.
6. Tap the **Time Format** field.
7. Tap the desired time format (**12 Hour** or **24 Hour**) in the pop-up dialog box.



8. Tap  to accept the change or  to cancel.

Time and date are configurable via web user interface at the path **Settings->Time & Date**.



Administrator Password

The **Advanced** option is only accessible to the administrator. The default administrator

password is "admin". For security reasons, you should change the default administrator password as soon as possible.

To change the administrator password via phone user interface:

1. Tap **Settings** from the Home screen.
2. Enter the admin password (default password: admin) from the **Advanced** block.
3. Tap **Set Password**.
4. Enter the current password in the **Current PWD** field.
5. Enter the new password in the **New PWD** field.
6. Re-enter the new password in the **Confirm PWD** field.

7. Tap  to accept the change or  to cancel.

Administrator password is configurable via web user interface at the path **Security->Password**.

Phone Lock

You can lock your phone temporarily when you are not using it. This feature helps to protect your phone from unauthorized use.

When the phone is locked, mute touch keys and touch screen (except ) are locked. You are only allowed to:

- Dial emergency numbers.
- Reject incoming calls.
- Answer incoming calls.
- End the call.

Note

The emergency number setting, if desired, must be made before lock activation. For more information, refer to [Emergency Number](#) on page 121.

Configuring a Phone Lock Key

To configure a phone lock key via phone user interface:

1. Tap **Settings** from the Home screen.

2. Tap **DSS Keys** from the **Features** block.
3. Tap the desired line key.
4. Tap the **Type** field.
5. Tap **Key Event** in the pop-up dialog box.
6. Tap the **Key Type** field.
7. Tap **Phone Lock** in the pop-up dialog box.
8. (Optional.) Enter the string that will appear on the touch screen in the **Label** field.

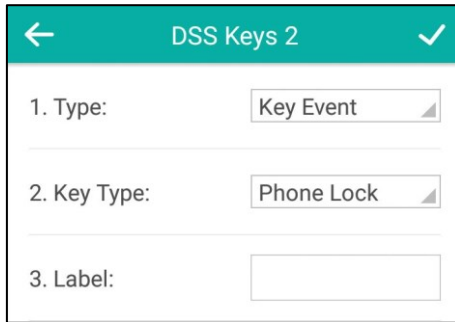

9. Tap ✓ to accept the change or ← to cancel.

Phone lock key is configurable via web user interface at the path **DSSKey->Line key**.

Activating the Phone Lock

To activate the phone lock via phone user interface:

1. Tap **Settings** from the Home screen.
2. Enter the admin password (default password: admin) from the **Advanced** block.
3. Tap **Phone Lock**.
4. Tap the **Lock Enable** field.
5. Tap **Enabled** in the pop-up dialog box to enable this feature.
6. Enter the desired interval of automatic phone lock in the **Lock Time Out** field.

The default timeout is 0. It means the phone will not be automatically locked. You need to tap the phone lock key to lock it immediately when the phone is idle.

If set to other values except 0 (e.g., 5), the phone will be locked when the phone is inactive in idle screen for the designated time (in seconds).

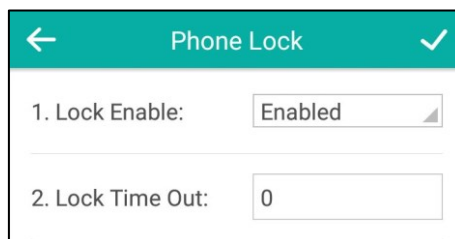

7. Tap ✓ to accept the change.

When the phone is locked, the touch screen prompts “Phone locked.” and displays the icon  on the status bar.

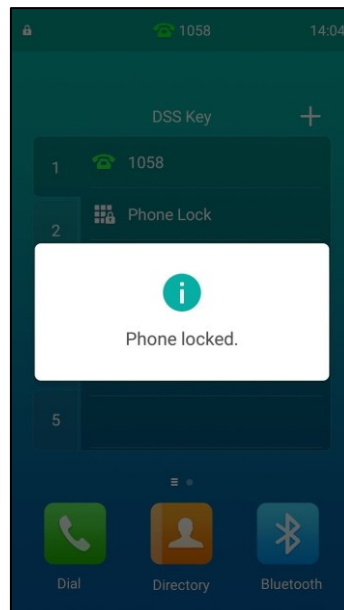

Unlocking the Phone

To unlock the phone, you must know the phone unlock PIN. The default phone unlock PIN is “123”.

To unlock the phone via phone user interface:

1. Tap the screen or tap the Mute touch key, the touch screen prompts “Unlock PIN”.
2. Enter the PIN in the **Unlock PIN** field.

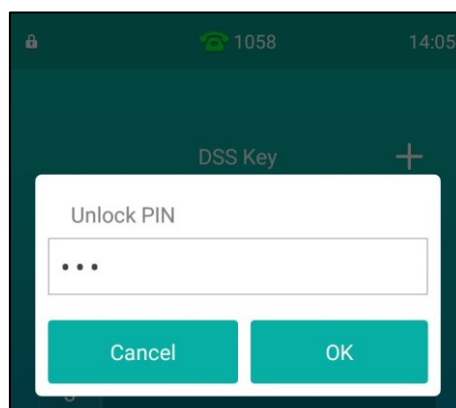

3. Tap **OK** to unlock the phone.

The icon  disappears from the status bar.

You can tap the phone lock key or wait for a period of time (if configured) to lock the phone again.



Note

You can also unlock the phone by administrator password. When you enter the administrator password to unlock the phone, the phone will turn to the Change PIN screen.

Changing the Phone Unlock PIN

To change the phone unlock PIN via phone user interface:

1. Tap **Settings** from the Home screen.
2. Tap **Change PIN** from the Basic block.
3. Enter the desired value in the **Current PIN**, **New PIN** and **Confirm PIN** field respectively.

4. Tap  to accept the change or  to cancel.

Note The unlock PIN length must be within 15 digits.

Deactivating the Phone Lock

To deactivate the phone lock via phone user interface:

1. Tap **Settings** from the Home screen.
2. Enter the admin password (default password: admin) from the **Advanced** block.
3. Tap **Phone Lock**.
4. Tap the **Lock Enable** field.
5. Tap **Disabled** in the pop-up dialog box to disable this feature.

6. Tap  to accept the change.

Phone lock is configurable via web user interface at the path **Features->Phone Lock**.

Audio Settings

Volume

For CP960 IP phone, you can adjust the following volume level:

- **Ringer volume:** Tap the Volume touch key to adjust the ringer volume when the phone is idle or ringing. When adjusting ringer volume, the touch sound and notification sound volume will change as well. For more information on ring tones, touch sounds and/or notification sound, refer to [Ring Tones](#) on page 77, [Touch Sounds](#) on page 80 and/or [Notification Sound](#) on page 81.
- **Talking volume:** Tap the Volume touch key to adjust the receiver volume of speakerphone when the phone is in use.
- **Key tone volume:** Tap the Volume touch key to adjust the key tone volume when the phone is on the dialing screen. For more information on key tone, refer to [Key Tone](#) on page 80.
- **Media volume:** Tap the Volume touch key to adjust the media volume when playing audios.

To adjust the ringer volume:

1. Tap one of the Volume touch key to increase or decrease the ringer volume.

When the phone is idle:

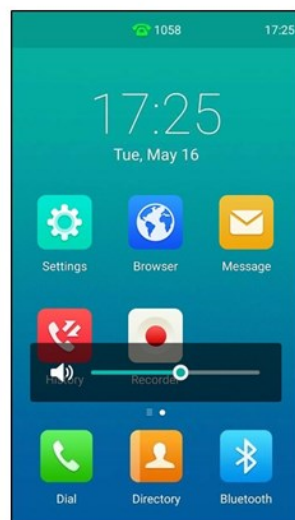

When the phone is ringing:

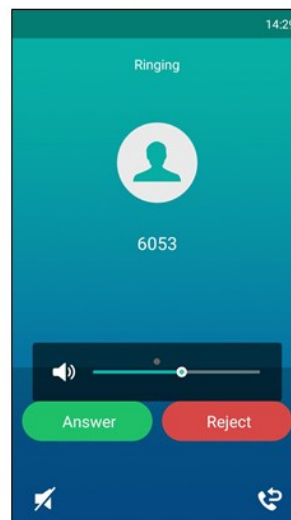

You can also tap the Volume touch key to adjust the ringer volume when selecting a ring tone. For more information, refer to [Ring Tones](#) on page 77.

Note

If the ringer volume is adjusted to minimum, the icon  will appear on the status bar.

You can also drag the volume slider to adjust the ringer volume.

To adjust the talking volume:

When the phone is during a call:

1. Tap one of the Volume touch key to increase or decrease the volume of speakerphone.

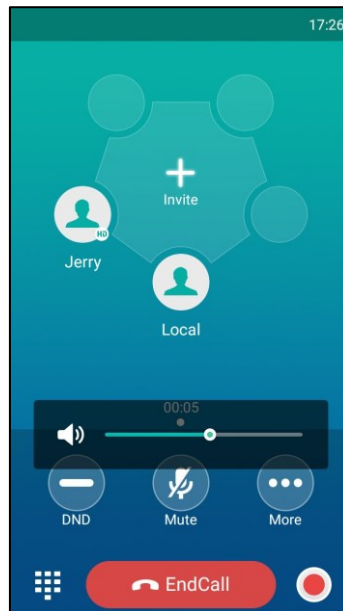

You can also drag the volume slider to adjust the talking volume.

To adjust the key tone volume:

When the phone is on the dialing screen:

1. Tap one of the Volume touch key to increase or decrease the key tone volume.

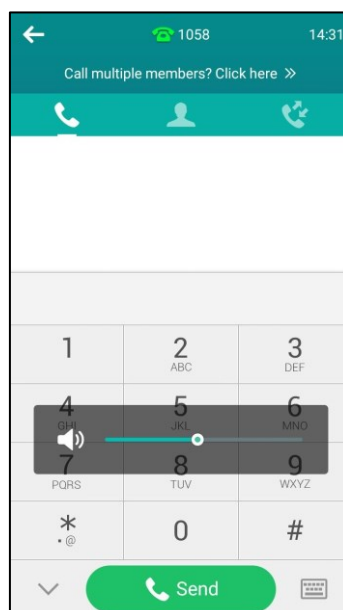

You can also drag the volume slider to adjust the key tone volume.

To adjust the media volume:

You can adjust the media volume in multiple scenarios. The following takes playing the recorded file by **Recorder** application as example:

1. Tap one of the Volume touch key to increase or decrease the media volume.

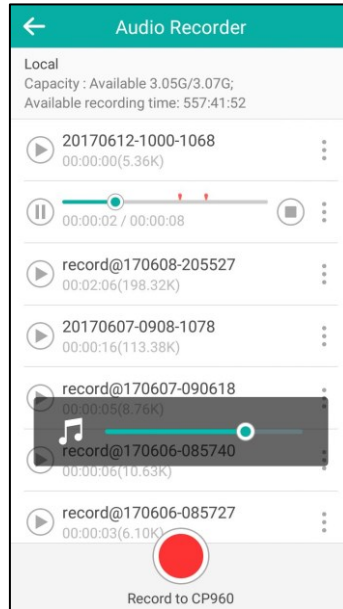

You can also drag the volume slider to adjust the media volume.

Ring Tones



Ring tones are used to indicate incoming calls. You can select different ring tones to distinguish your phone from your neighbor's, you can also select ring tone for contacts on your phone.

To select a ring tone for the phone via phone user interface:

1. Tap **Settings** from the Home screen.
2. Tap **Sound** from the **Basic** block.
3. Tap **Ring Tones**->**Common**.
4. Drag up and down to scroll through the list of available ring tones.

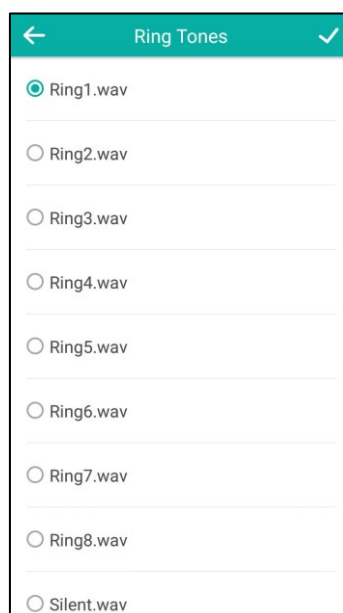
5. Tap the desired ring tone.



6. (Optional.) Tap one of the Volume touch key to increase or decrease the ringer volume.
7. Tap  to accept the change or  to cancel.

A ring tone for the phone is configurable via web user interface at the path **Settings->Preference->Ring Type**.



To select a ring tone for the account via phone user interface:

1. Tap **Settings** from the Home screen.
2. Tap **Sound** from the **Basic** block.
3. Tap **Ring Tones**.
4. Tap the desired account.
5. Drag up and down to scroll through the list of available ring tones.

6. Tap the desired ring tone.

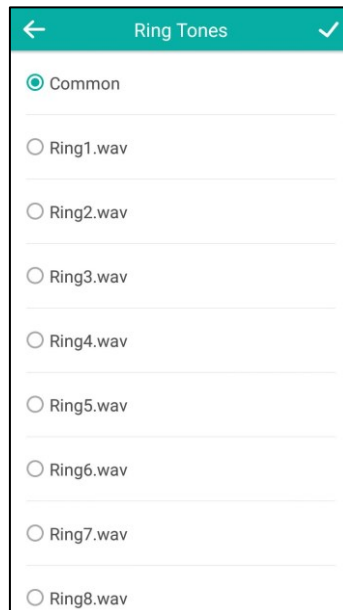
If **Common** is selected, this account will use the ring tone selected for the phone.



7. (Optional.) Tap one of the Volume touch key to increase or decrease the ringer volume.
8. Tap  to accept the change or  to cancel.

A ring tone for the account is configurable via web user interface at the path

Account->Basic->Ring Type.

To upload a custom ring tone for your phone via web user interface:

1. Click on **Settings->Preference.**
2. In the **Upload Ringtone** field, click **Browse** to locate a ring tone file (the file format must be *.wav) from your local system.

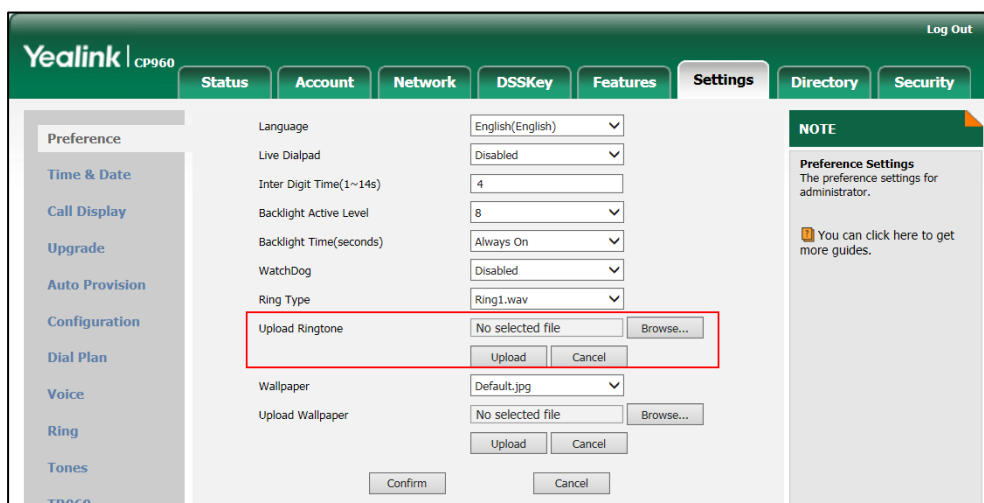

3. Click **Upload** to upload the file.

The custom ring tone appears in the pull-down list of **Ring Type.**

You can only delete the custom ringtone by clicking **Del** in the **Ring Type** field.

Note

The priority of ring tone for an incoming call on the phone is as follows:
Contact ring tone (refer to [Adding Contacts](#)) > Group ring tone (refer to [Adding Groups](#)) > Account ring tone > Phone ring tone.

Single custom ring tone file must be within 8MB. Uploading custom ring tones for your phone is configurable via web user interface only.

Key Tone

If you enable key tone, the phone will produce a sound when you tap the onscreen dial pad.

To enable key tone via phone user interface:

1. Tap **Settings** from the Home screen.
2. Tap **Sound** from the **Basic** block.
3. Tap **Key Tone**.
4. Turn on **Key Tone**.

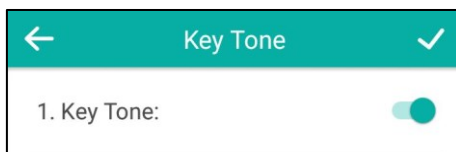

5. Tap ✓ to accept the change or ← to cancel.

Key tone is configurable via web user interface at the path **Features->Audio**.



Touch Sounds

If you enable touch sounds, the phone will produce a sound when you tap an option on the touch screen.

To enable touch sounds via phone user interface:

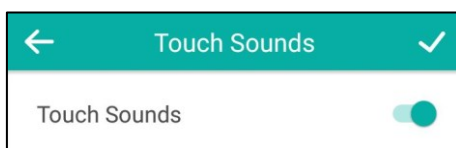
1. Tap **Settings** from the Home screen.
2. Tap **Sound** from the **Basic** block.
3. Tap **Touch Sounds**.
4. Turn on **Touch Sounds**.



5. Tap  to accept the change or  to cancel.

Note Touch sound is configurable via phone user interface only.

Notification Sound

To select a notification sound for the phone via phone user interface:

1. Tap **Settings** from the Home screen.
2. Tap **Sound** from the **Basic** block.
3. Tap the **Notification Sound** field.
4. Tap the desired notification sound in the pop-up dialog box.

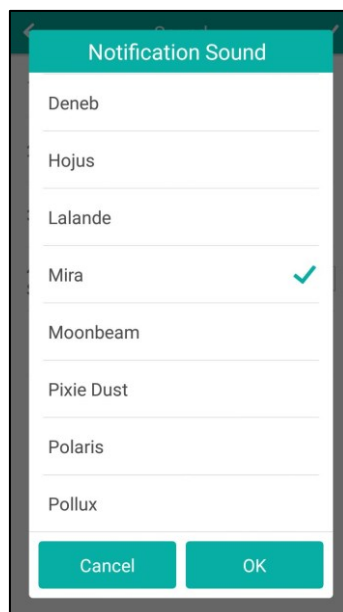

5. (Optional.) Tap one of the Volume touch key to increase or decrease the notification sound.
6. Tap **OK** to accept the change or **Cancel** to cancel.

Note Notification sound is configurable via phone user interface only.

Silent Mode



If you turn on the silent mode, the IP phone won't produce ring tone/key tone/touch sound/notification sound from phone's speaker.

To enable the silent mode via phone user interface, do one of the following:

- Tap **Settings** from the Home screen.
- Tap **Sound** from the **Basic** block.

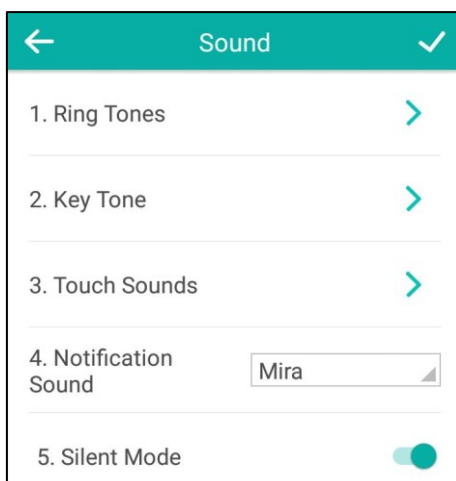
Turn on **Silent Mode**.



Tap  to accept the change or  to cancel.

- Long tap the left Volume touch key to decrease the ringer volume to minimum.
- Swipe down from the top of the screen to enter the control center and toggle **Silent** on.

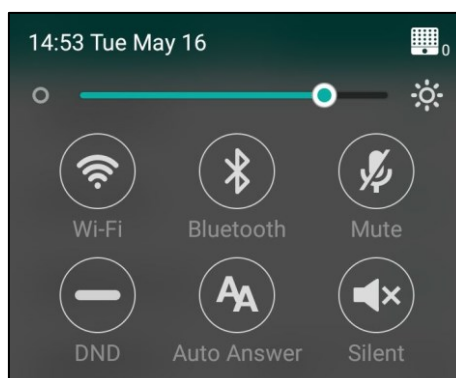

Note

Silent mode is configurable via phone user interface only.
You may have no permission to turn on the silent mode. Contact your system administrator for more information.

Contact Management

This section provides the operating instructions for managing contacts. Topics include:



- [Local Directory](#)
- [Blacklist](#)
- [Remote Phone Book](#)

Local Directory

The built-in phone directory can store the names and phone numbers of your contacts. You can store up to 1000 contacts and 48 groups in your phone's local directory. You can add new groups and contacts, edit, delete or search for a contact, or simply dial a contact number from the local directory.

Adding Groups

To add a group to the local directory:

1. Tap .
2. Tap .
3. Tap  after **Custom Grouping**.
4. Enter the desired group name.

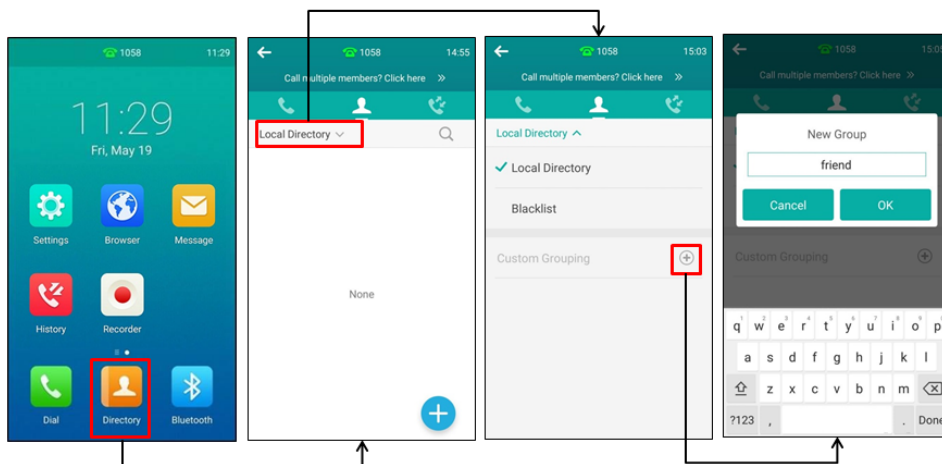

5. Tap **OK** to accept the change.
6. Tap  after the group name and then tap **Ring** to specify a ring tone for the group.

7. Tap the desired ring tone in the pop-up dialog box.

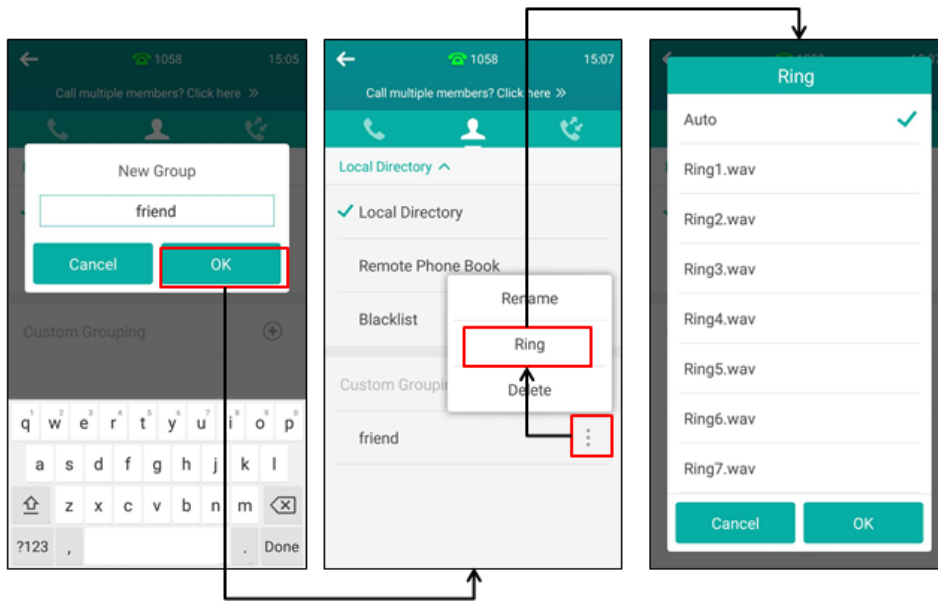



If **Auto** is selected, this group will use the ring tone according to the priority: Contact ring tone (refer to [Adding Contacts](#)) >Account ring tone (refer to [Ring Tones](#)) >Phone ring tone (refer to [Ring Tones](#)). If a specific ring tone is selected, this group will use the ring tone according to the priority: Contact ring tone (refer to [Adding Contacts](#)) >Group ring tone.

8. Tap **OK** to accept the change.

Editing Groups

To edit a group in the local directory:

1. Tap .
2. Tap .
3. Tap  after desired group and then tap **Rename**.

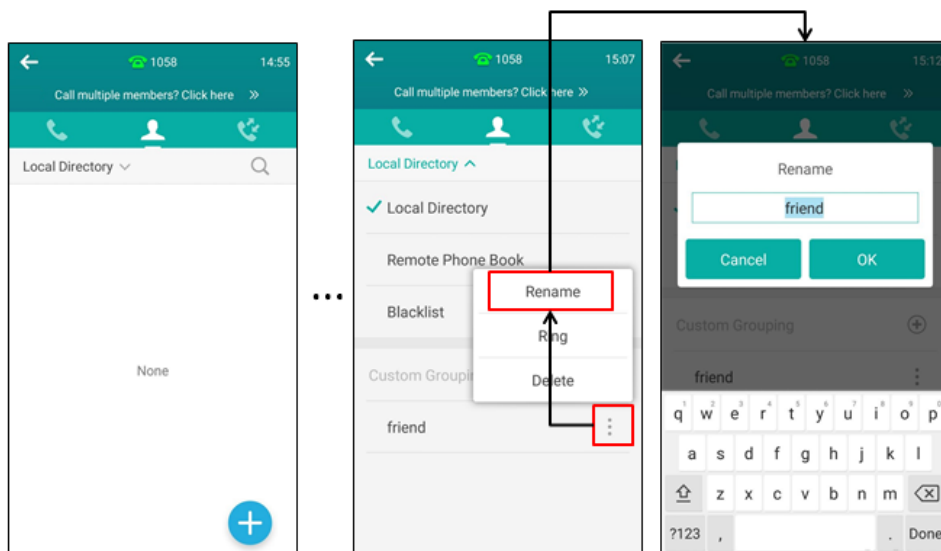

4. Edit the group name in the highlighted field.



5. Tap **OK** to accept the change.

Deleting Groups

To delete a group from the local directory:

1. Tap .
2. Tap .
3. Tap  after desired group and then tap **Delete**.

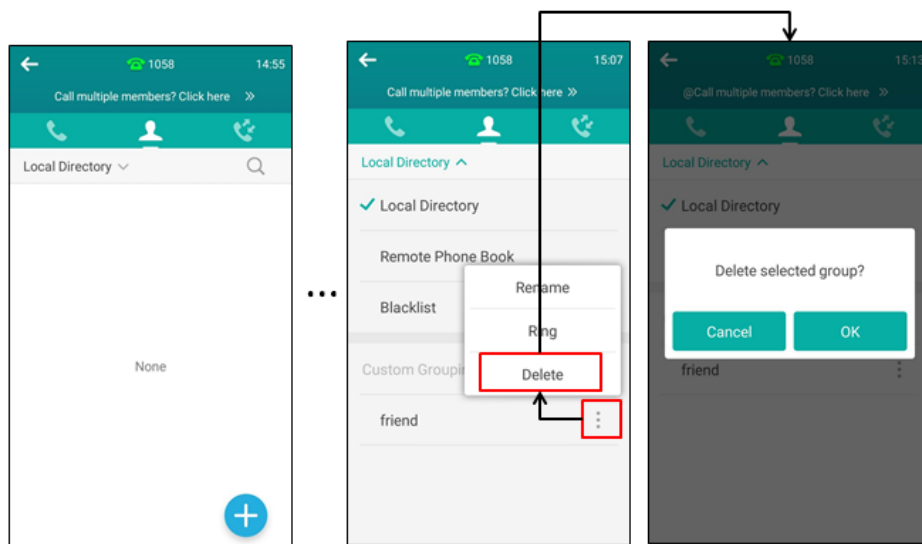

4. Tap **OK** to accept the change or **Cancel** to cancel.

Adding Contacts

You can add contacts to the local directory in one of the following ways:

- Manually
- From call history
- From a remote phone book

Adding Contacts Manually

To add a contact to the local directory manually:

1. Tap .
2. Tap .

If you want to add a contact to the specified contact group, you can tap Local Directory ▾ and then tap the contact group, then tap .

3. Enter the name and the office, mobile or other numbers in the corresponding fields.
4. Tap the **Account** field.
5. Tap the desired account in the pop-up dialog box.

If **Auto** is selected, the phone will use the default account when placing calls to the contact from the local directory.

6. Tap the **Ring** field.
7. Tap the desired ring tone in the pop-up dialog box.

If **Auto** is selected, this contact will use the ring tone according to the priority: Group ring tone (refer to [Adding Groups](#)) > Account ring tone (refer to [Ring Tones](#)) > Phone ring tone (refer to [Ring Tones](#)).

8. Tap the **Photo** field.
9. Tap the desired photo in the pop-up dialog box.

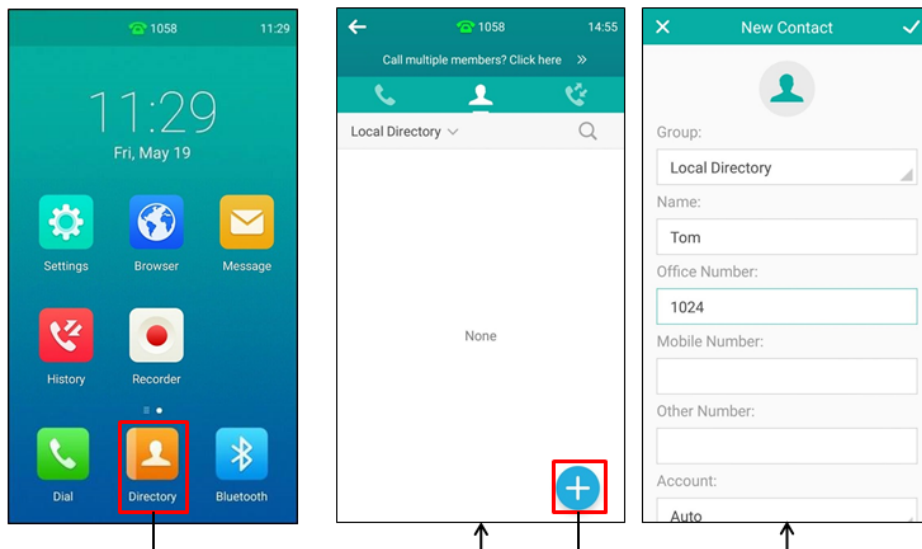



10. Tap ✓ to accept the change or tap ✕ and then tap **Discard** to cancel.

Note

If the contact already exists in the directory, the touch screen will prompt "Contact name existed!".

Adding Contacts from Call History

To add a contact to the local directory from call history:

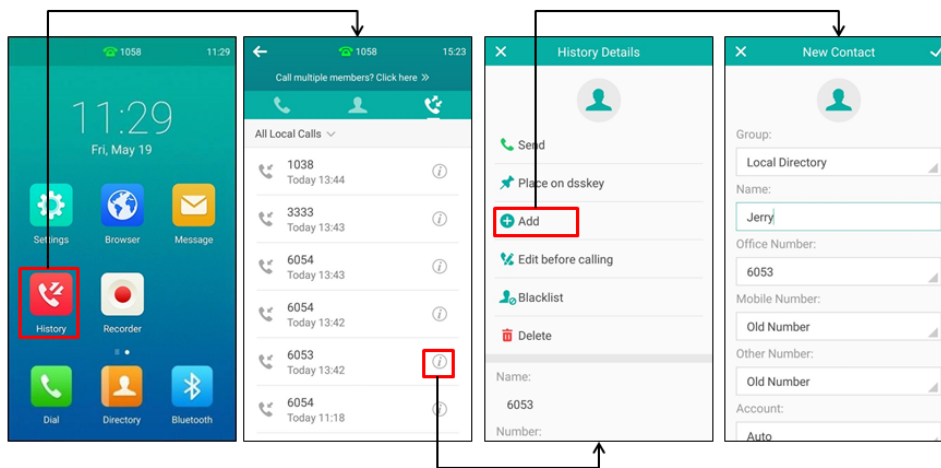

1. Tap .
2. Tap  after the desired entry.
3. Tap **Add**.
4. Edit the corresponding fields.



5. Tap ✓ to accept the change.
The entry is successfully saved to the local directory.

Adding Contacts from a remote phone book

To add a contact to the local directory from a remote phone book:

1. Tap .
2. Tap and then tap **Remote Phone Book**.
3. Tap the desired remote phone book.
The phone then connects to the remote phone book and proceeds to load it. The contacts in the remote phone book are displayed on the touch screen.
4. Tap  after the desired contact in the remote phone book.
5. Tap **Add**.

6. Edit the corresponding fields.

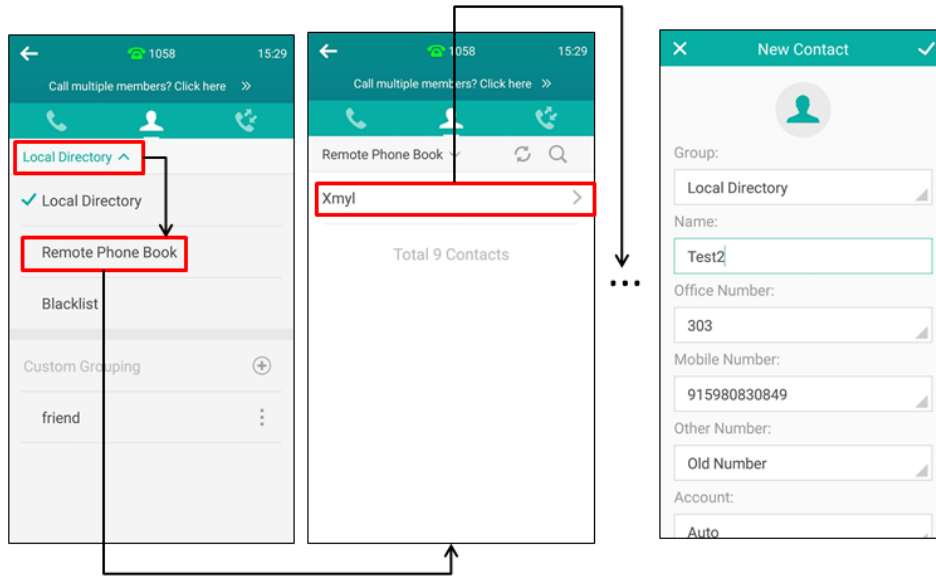



7. Tap ✓ to accept the change or tap ✕ and then tap **Discard** to cancel.
If the contact already exists in the local directory, the touch screen will prompt "Overwrite the original contact?". Tap **OK** to overwrite the original contact in the local directory or **Cancel** to cancel.

For more information on remote phone book operation, refer to [Remote Phone Book](#) on page 97.



Editing Contacts

To edit a contact in the local directory:

1. Tap 
2. Tap  after the desired contact.
If the contact was added to a specified contact group, you can tap Local Directory ▾ and then tap the contact group, then tap  after the desired contact.
3. Tap the desired field to edit the contact information.
4. Tap ✓ to accept the change or tap ✕ and then tap **Discard** to cancel.

Deleting Contacts

To delete a contact from the local directory:

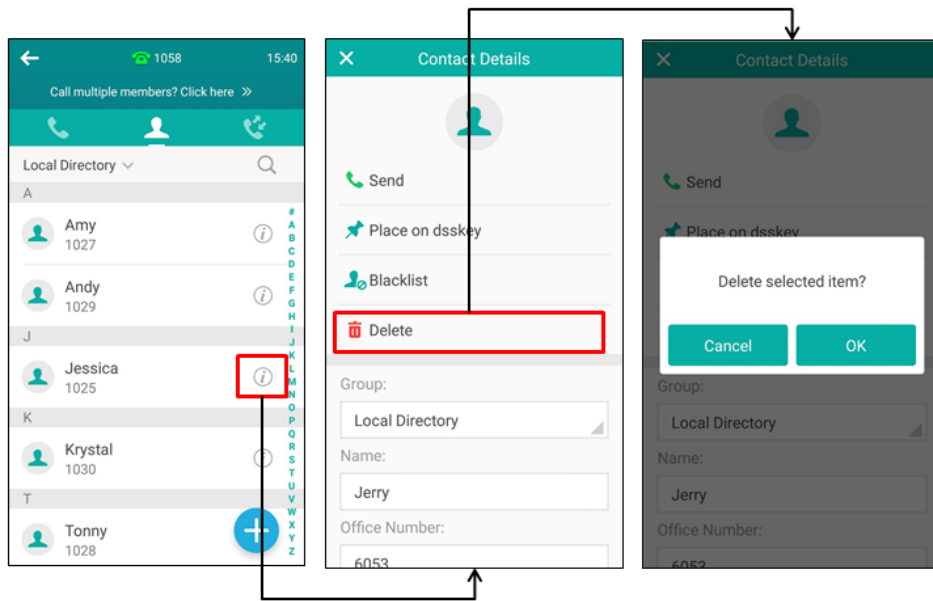

1. Tap 
2. Tap  after the desired contact.
If the contact was added to a specified contact group, you can tap Local Directory ▾ and then tap the contact group, then tap .

3. Tap **Delete**.



4. Tap **OK** to accept the change or **Cancel** to cancel.

To delete all contacts:

1. Tap 
2. Long tap a contact.
3. Tap the radio box on the top-right of the screen.
4. Tap  and then tap **Delete contacts**.

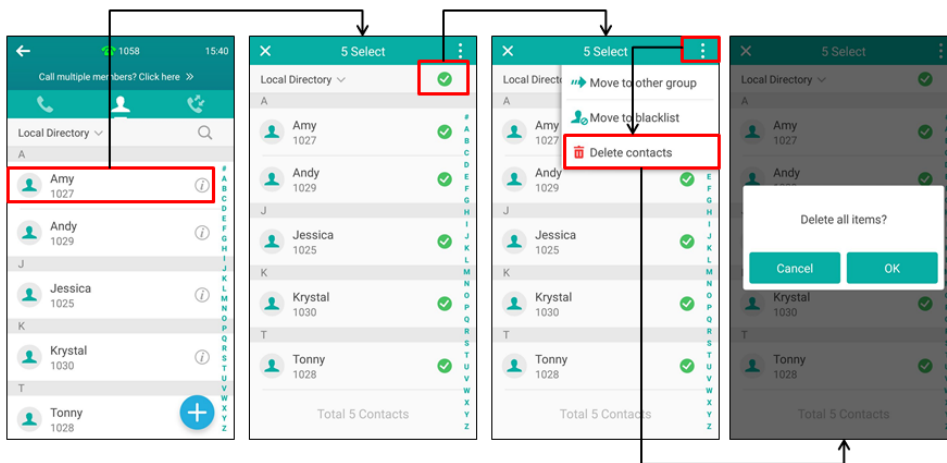

5. Tap **OK** to accept the change or **Cancel** to cancel.

Uploading Contact Photos

To upload a new custom photo for the contact via web user interface:

1. Click on **Directory**->**Local Directory**.
2. Click **Upload Photo**, and then locate and upload a photo file from your local computer.

The web user interface prompts "Upload success!".

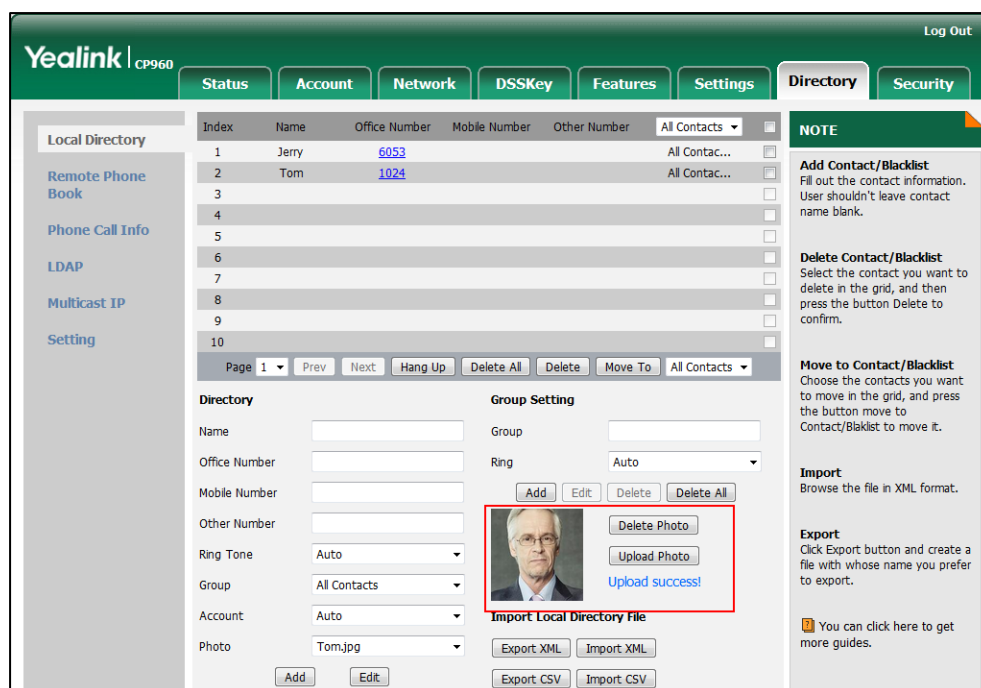

You can click **Delete Photo** to delete the custom photo.

Note

The phone only supports *.png, *.jpg, *.jpeg and *.bmp format files.

You can only delete custom photos.

To change the custom photo for the contact via web user interface:

1. Click on **Directory**->**Local Directory**.
2. Click the desired contact you want to edit.

3. Select the desired photo from the pull-down list of **Photo**.

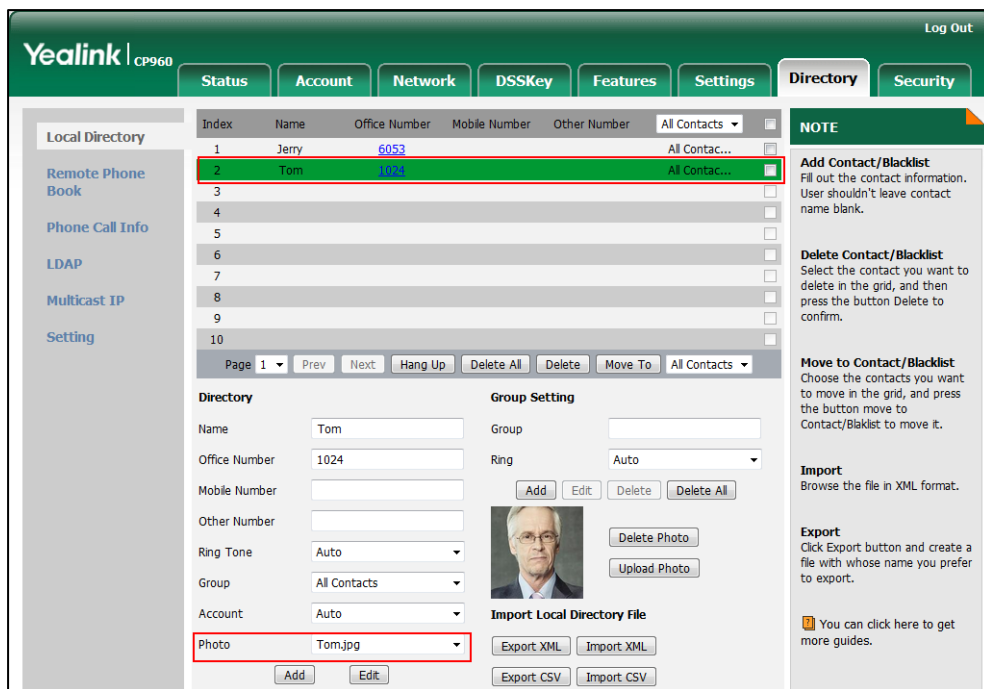

4. Click **Edit** to accept the change.

When you place a call to the contact or receive a call from the contact, the touch screen will display the contact photo.

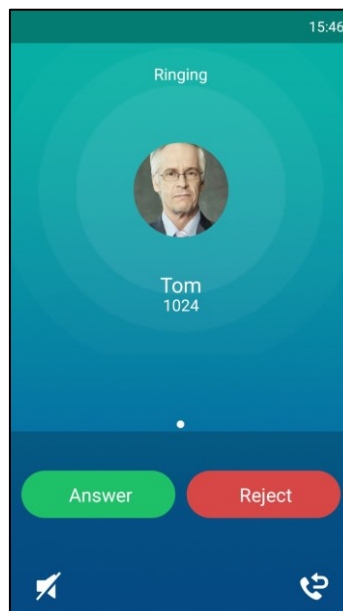

Placing Calls to Contacts

To place a call to a contact from the local directory:

1. Tap 



If the contact was added to a specified contact group, you can tap Local Directory ▾ and

then tap the contact group.

2. Tap the desired contact.
 - If only one number is stored in the local directory, the IP phone will dial out automatically.
 - If multiple numbers are stored in the local directory, tap the desired number to dial out.

Searching for Contacts

To search for a contact in the local directory:

1. Tap .
2. Do one of the following :
 - Tap .

Enter a few continuous characters of the contact name or continuous numbers of the contact number (office, mobile or other number) using the onscreen keyboard.

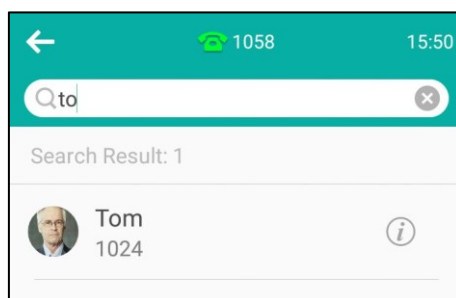

The contacts whose name or phone number matches the characters entered will appear on the touch screen. You can dial from the result list.

- Tap the desired letter (e.g., T) along the right side to jump to contacts whose names start with T or t.

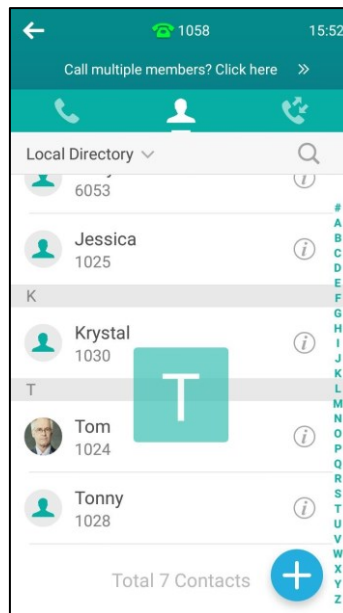

Importing/Exporting Contact Lists

You can manage your phone's local directory via phone user interface or web user interface. But you can only import or export the contact list via web user interface.

To import an XML contact list file via web user interface:

1. Click on **Directory**->**Local Directory**.
2. Click **Import XML** to locate and upload a contact list file (the file format must be *.xml) from your local system.

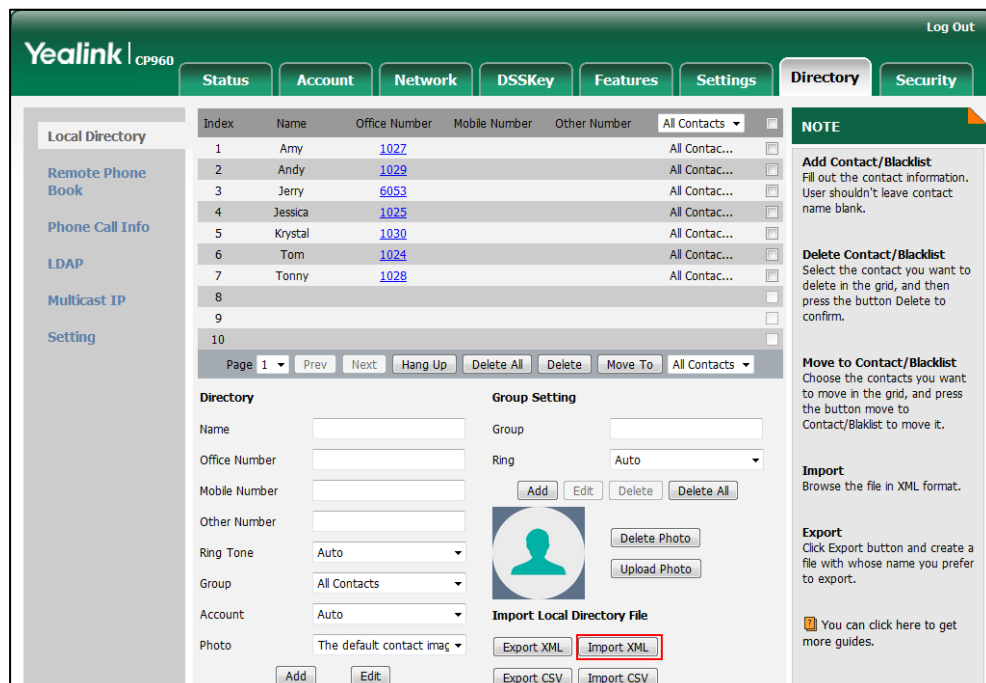

The web user interface prompts "The original contact will be covered, continue?".

3. Click **OK** to complete importing the contact list.

To import a CSV contact list file via web user interface:

1. Click on **Directory**->**Local Directory**.
2. Click **Import CSV** to locate and upload a contact list file (the file format must be *.csv) from your local system.

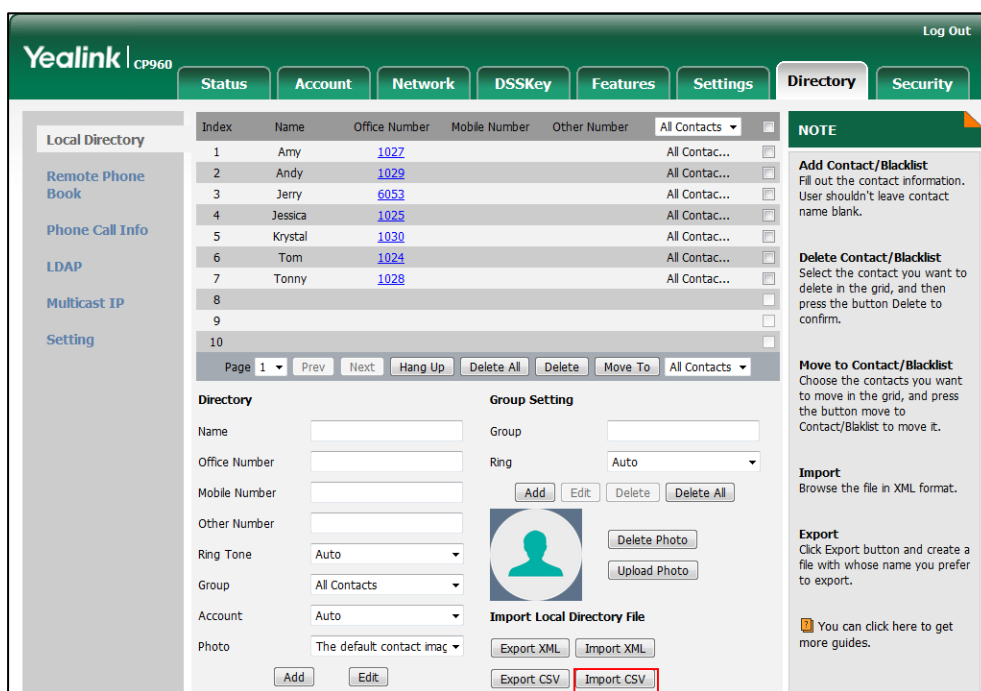

3. (Optional.) Check the **Show Title** checkbox.

It will prevent importing the title of the contact information which is located in the first line of the CSV file.

4. (Optional.) Check the **Delete Old Contacts** checkbox.

It will delete all existing contacts while importing the contact list.

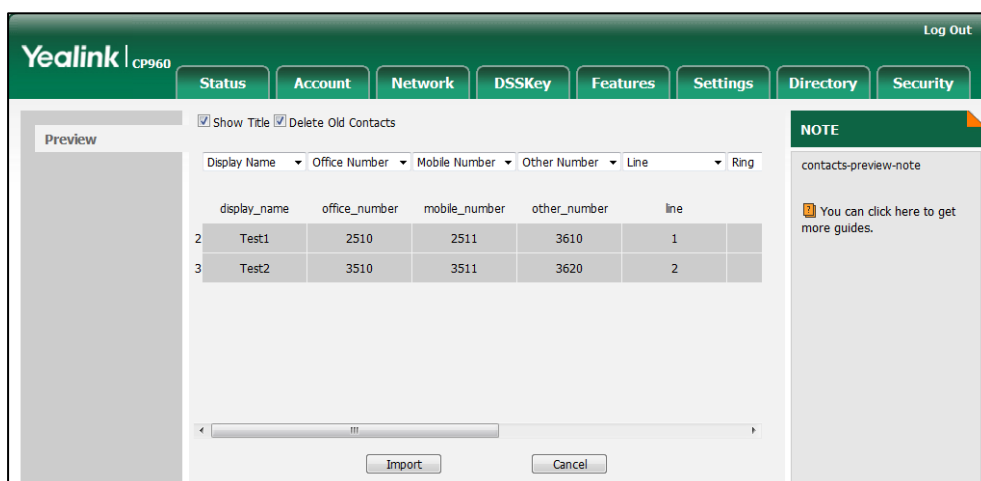

5. Click **Import** to complete importing the contact list.

To export a contact list via web user interface:

1. Click on **Directory->Local Directory**.
2. Click **Export XML** (or **Export CSV**).

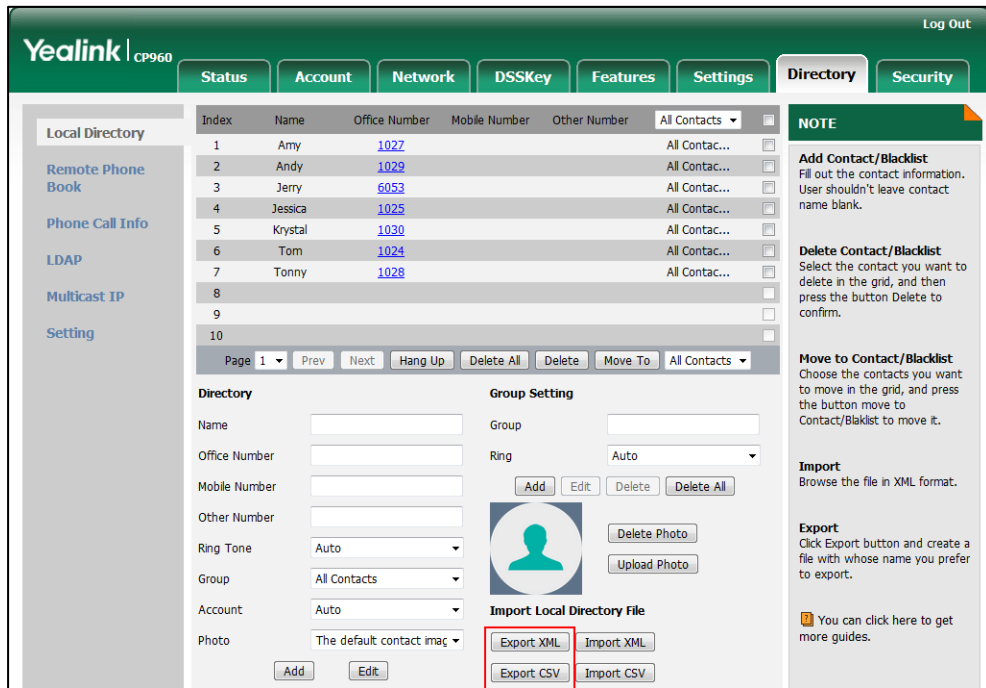

3. Click **Save** to save the contact list to your local system.

Note Importing/exporting contact lists is available via web user interface only.

Blacklist

The built-in phone directory can store names and phone numbers for a blacklist. You can store up to 30 contacts; add, edit, delete or search for a contact in the blacklist directory, and even call a contact from the blacklist directory. Incoming calls from the blacklist directory contacts will be rejected automatically.

To add a contact to the blacklist directory manually:

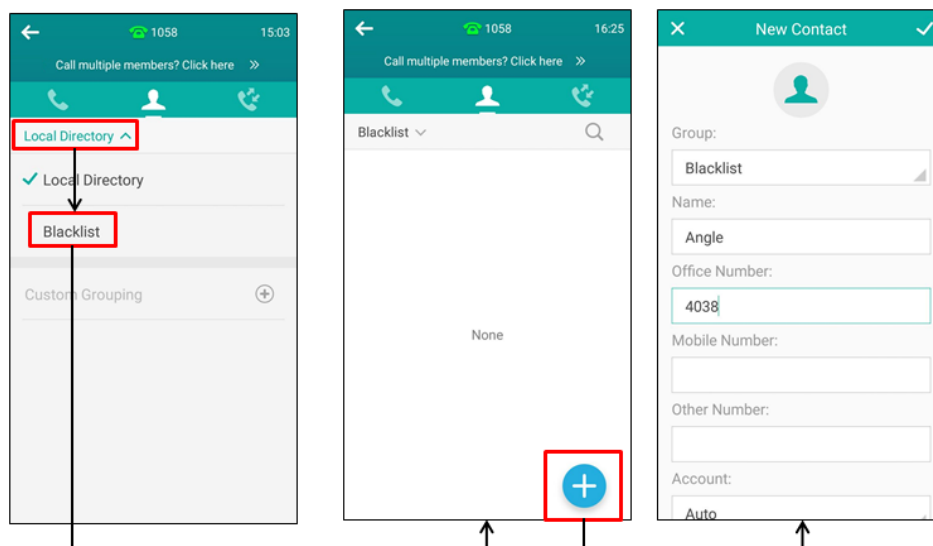

1. Tap 
2. Tap and then tap **Blacklist**.
3. Tap .

4. Enter the contact's name and the office, mobile or other numbers in the corresponding fields.
5. Tap the **Account** field.
6. Tap the desired account in the pop-up dialog box.
If **Auto** is selected, the phone will use the default account when placing calls to the contact from the blacklist directory.



7. Tap ✓ to accept the change or tap ✕ and then tap **Discard** to cancel.

To add a contact to the blacklist directory from the local directory:

1. Tap 
2. Tap  after the desired contact.

If the contact was added to a specified contact group, you can tap Local Directory ▾ and then tap the contact group, then tap  after the desired contact.

3. Tap **Blacklist**.

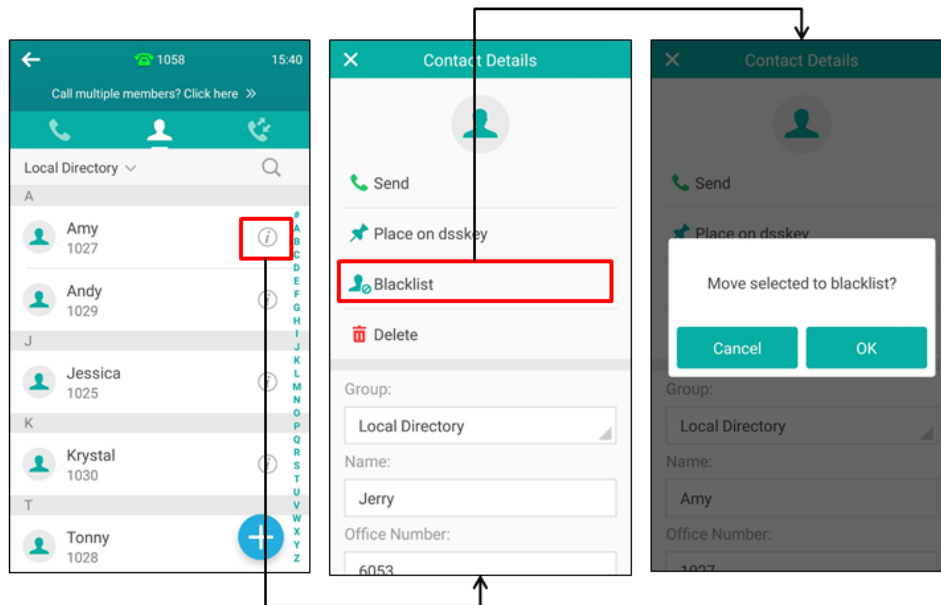

4. Tap **OK** to accept the change.

For operating instructions on editing, deleting, placing calls to and/or searching for contacts in the blacklist directory, refer to the operating instructions of [Editing Contacts](#) on page 88, [Deleting Contacts](#) on page 88, [Placing Calls to Contacts](#) on page 91 and/or [Searching for Contacts](#) on page 92.

Remote Phone Book

You can add contacts to the local directory, search for a contact, or simply dial a contact number from the remote phone book.

You can configure your new phone to access up to 5 remote phone books. The phone supports up to 5000 remote phone book entries. For the access URL of the remote phone book, contact your system administrator.

For operating instructions on placing calls to and/or searching for contacts in the remote phone book, refer to the operating instructions of [Placing Calls to Contacts](#) on page 91 and/or [Searching for Contacts](#) on page 92.

Configuring an Access URL

To configure an access URL for a remote phone book via web user interface:

1. Click on **Directory->Remote Phone Book**.
2. Enter the access URL in the **Remote URL** field.
3. Enter the name in the **Display Name** field.

- Enter the desired refresh period in the **Update Time Interval(Seconds)** field.
The default value is 21600.

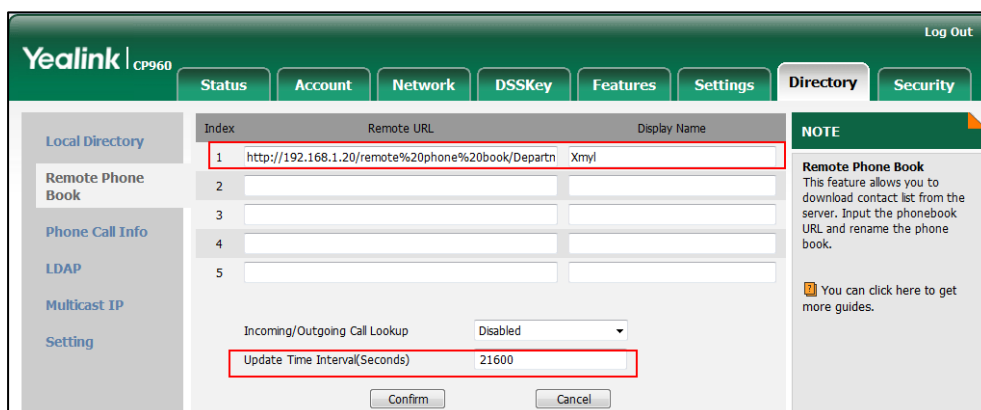

- Click **Confirm** to accept the change.

Note An access URL for a remote phone book is configurable via web user interface only.

Accessing the Remote Phone Book

To access your remote phone book via phone user interface:

- Tap 
- Tap and then tap **Remote Phone Book**.
- Tap the desired remote phone book.

The phone then connects to the remote phone book and proceeds to load it. The contacts in the remote phone book are displayed on the touch screen.

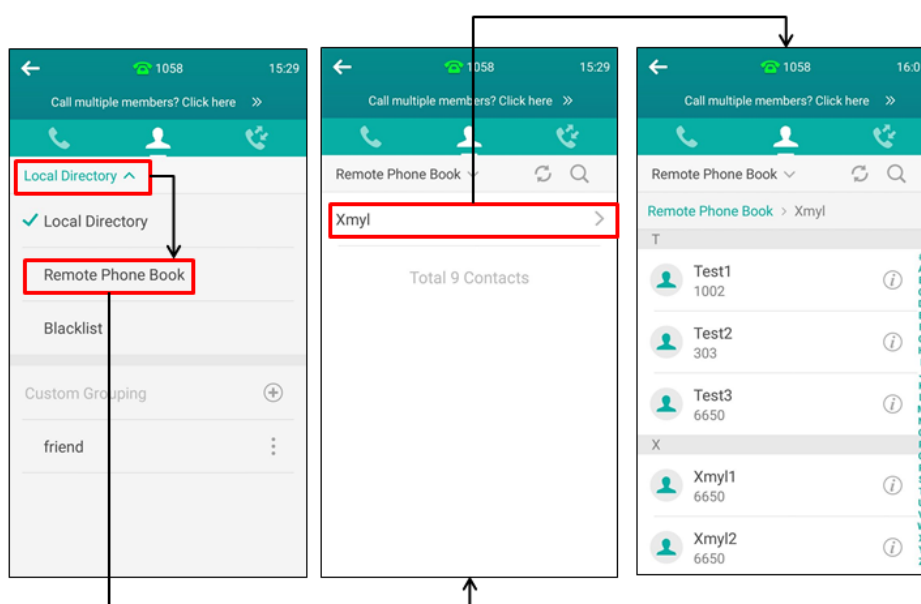

Incoming/Outgoing Call Lookup

You can enable the phone to present the caller/callee identity stored in the remote phone book when receiving/placing a call.

To configure incoming/outgoing call lookup via web user interface:

1. Click on **Directory**->**Remote Phone Book**.
2. Select **Enabled** from the pull-down list of **Incoming/Outgoing Call Lookup**.

The screenshot shows the Yealink CP960 web interface. The top navigation bar includes 'Status', 'Account', 'Network', 'DSSKey', 'Features', 'Settings', 'Directory', and 'Security'. The 'Directory' tab is active, and the 'Remote Phone Book' sub-tab is selected. A table with columns 'Index', 'Remote URL', and 'Display Name' is visible. Below the table, the 'Incoming/Outgoing Call Lookup' dropdown is set to 'Enabled' and is highlighted with a red box. The 'Update Time Interval(Seconds)' is set to 21600. A 'NOTE' section on the right explains the Remote Phone Book feature.

3. Click **Confirm** to accept the change.

Call History Management

The CP960 IP phone maintains call history lists of Missed calls, Placed calls, Received calls and Forwarded calls. Each call history list supports up to 100 entries. You can view call history, place a call, add a contact or delete an entry from the call history list.

History record feature is enabled by default, if you don't want to save the call history, you can disable the feature.

Viewing History Records

To view call history:

1. Tap 

The touch screen displays all call records.
2. Drag up and down to scroll.

You can tap All Local Calls and then tap **Missed Calls**, **Placed Calls**, **Received Calls** or **Forwarded Calls** to view entries in each call list directly.

3. Tap ⓘ after the desired entry.
The detailed information of the entry appears on the touch screen.

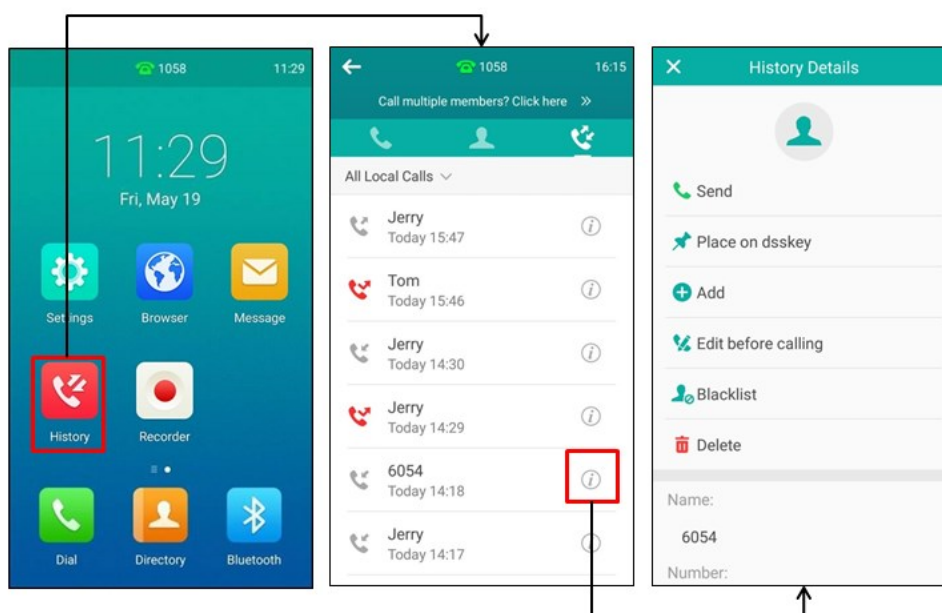

Placing a Call from History Records

To place a call from the call history list:

1. Tap .
The touch screen displays all call records.
2. Drag up and down to scroll.
You can tap and then tap **Missed Calls**, **Placed Calls**, **Received Calls** or **Forwarded Calls** to view entries in each call list directly.
3. Do one of the following:
 - Tap the desired entry.
 - Tap ⓘ after the desired entry.
Tap **Edit before calling**.
Edit the number.
Tap **Send**.

Adding a Contact to the Blacklist

To add a contact to the blacklist directory from the call history list:

1. Tap .
The touch screen displays all call records.

2. Drag up and down to scroll.
You can tap and then tap **Missed Calls**, **Placed Calls**, **Received Calls** or **Forwarded Calls** to view entries in each call list directly.
3. Tap ⓘ after the desired entry.
4. Tap **Blacklist**.
5. Enter the desired values in the corresponding fields.

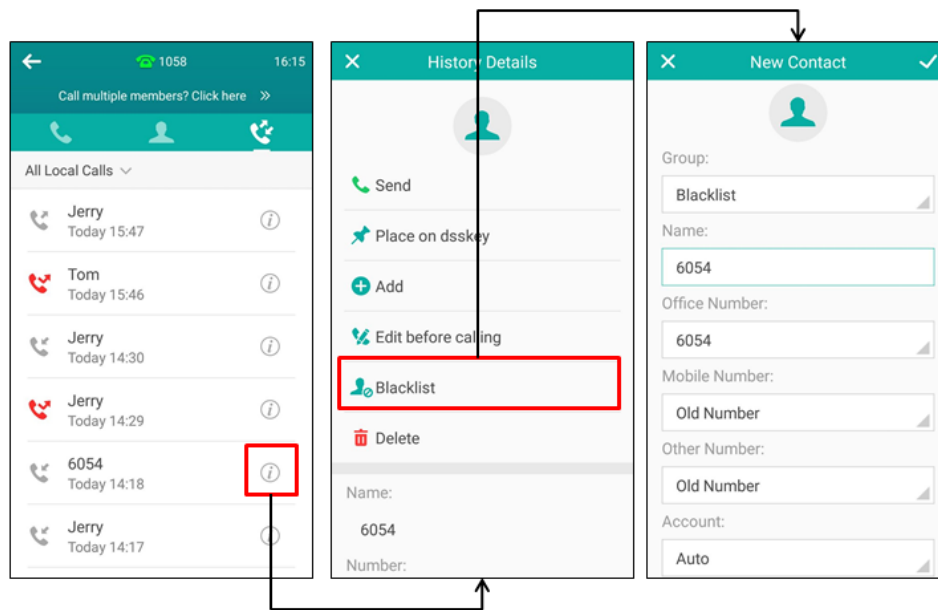

6. Tap ✓ to accept the change or tap ✕ and then tap **Discard** to cancel.

For more information, refer to [Blacklist](#) on page 95.

Deleting History Records

To delete an entry from the call history list:

1. Tap 
The touch screen displays all call records.
2. Drag up and down to scroll.
You can tap and then tap **Missed Calls**, **Placed Calls**, **Received Calls** or **Forwarded Calls** to view entries in each call list directly.
3. Tap ⓘ after the desired entry.

4. Tap **Delete**.

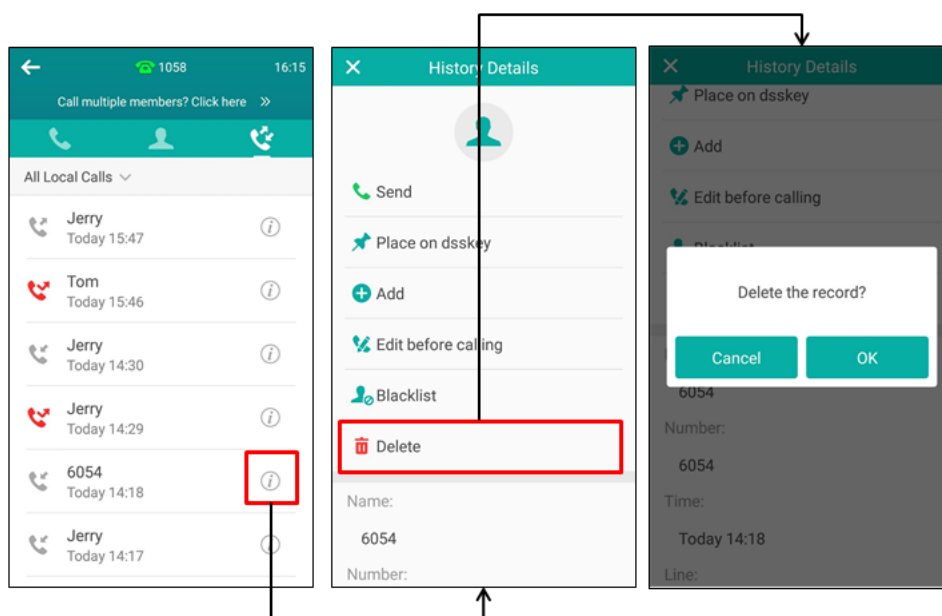

5. Tap **OK** to confirm the deletion or **Cancel** to cancel.

To delete all entries from the call history list:

1. Tap 

The touch screen displays all call records.
2. Drag up and down to scroll.

You can tap and then tap **Missed Calls**, **Placed Calls**, **Received Calls** or **Forwarded Calls** to view entries in each call list directly.
3. Long tap a contact.
4. Tap the radio box on the top-right of the screen.
5. Tap  and then tap **Delete calls**.

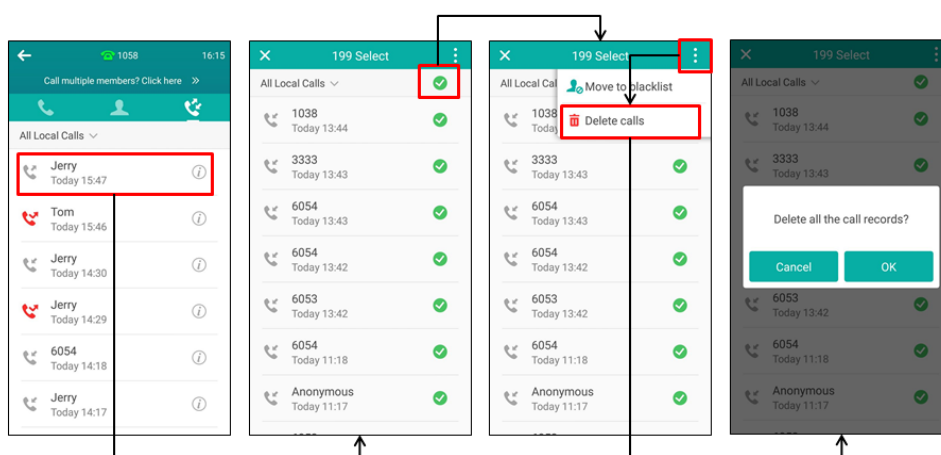



6. Tap **OK** to confirm the deletion or **Cancel** to cancel.

Disabling History Records

To disable history record via phone user interface:

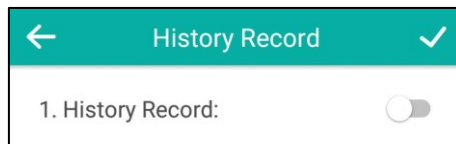
1. Tap **Settings** from the Home screen.
2. Tap **History Record** from the **Features** block.
3. Turn off **History Record**.



4. Tap  to accept the change or  to cancel.



Search Source List in Dialing

You can search for a contact from the desired lists when the phone is in the dialing screen. The lists can be Local Directory, History, Remote Phone Book and LDAP.

To configure search source list in dialing via web user interface:

1. Click on **Directory**->**Setting**.
2. In the **Search Source List In Dialing** block, select the desired list from the **Disabled** column and click .

The selected list appears in the **Enabled** column.

3. Repeat the step 2 to add more lists to the **Enabled** column.
4. (Optional.) To remove a list from the **Enabled** column, select the desired list and then click .
5. To adjust the display order of the enabled list, select the desired list, and click  or .

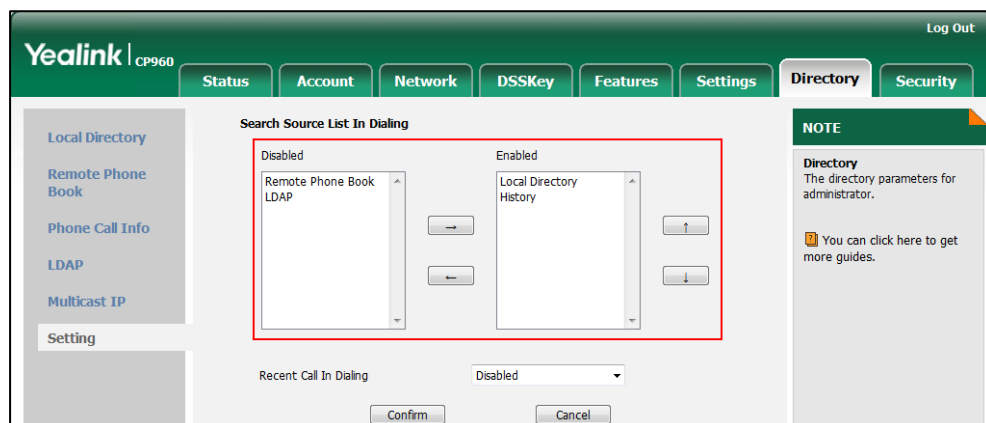

6. Click **Confirm** to accept the change.

The touch screen will display search results in the adjusted order.

Note Search source list in dialing is configurable via web user interface only.

To search for an entry in the enabled search source lists:

1. Tap the line key.
2. Enter a few continuous characters of the entry's name or continuous numbers of the entry's phone number (office, mobile or other number).

The entries in the enabled search source lists whose name or phone number matches the characters entered will appear on the touch screen.

You can tap the desired entry to place a call to the entry.

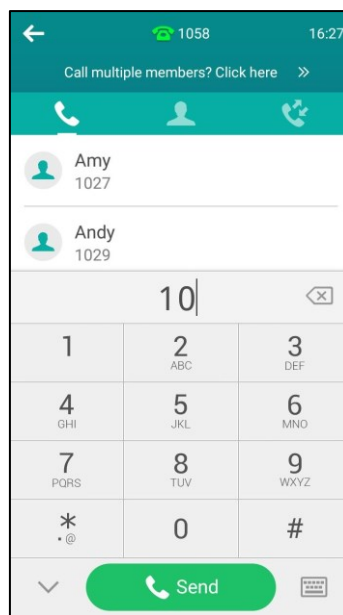

System Customizations

Line Keys



The CP960 IP phone supports 30 line keys. You can assign predefined functionalities to line keys. You can also define a label for a line key feature which will appear on the touch screen. Line keys allow you to quickly access features such as recall and voice mail. The line key can indicate the monitored status when the line keys are assigned with particular features, such as BLF. The default key type of line key 1 is Line. The default key type of line key 2-30 is N/A, which indicates that this line key provides no functionality until configuration.

Assigning Functionality to a Line Key

To assign functionality to a line key via phone user interface:

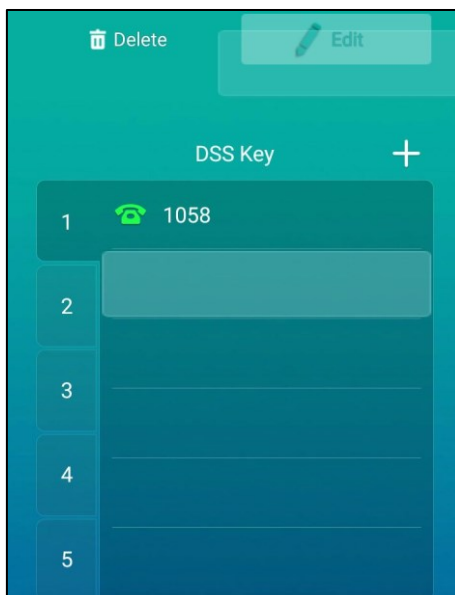
1. Do one of the following:
 - (Optional.) Tap the desired page key.
 - Drag the line key to the **Edit** field.



- Tap  on the top-right of the line key list.
 - Tap **Settings** from the Home screen.
 - Tap **DSS Keys** from the **Features** block.
 - Tap the desired line key.
2. Select the desired key type from the **Type** field.
 3. (Optional.) Select the desired key event type from the **Key Type** field.
 4. (Optional.) Select the desired line from the **Account ID** field.
 5. (Optional.) Enter the string that will appear on the touch screen in the **Label** field.
 6. (Optional.) Enter the corresponding value in the **Value** field.
 7. (Optional.) Enter the corresponding value in the **Extension** field.
 8. Tap  to accept the change or  to cancel.

Changing the Location of the Line Keys

You can change the line key's location to a blank area on the Line keys field. You can also change the location of two line keys. And the operating instructions are almost the same. The following takes how to change the location of two line keys as example.

To change the locations of two line keys:

1. Tap the desired page key if required.

2. Drag a line key to the desired location at which another line key locates.

For example, exchange the locations of line key 1 and line key 2:

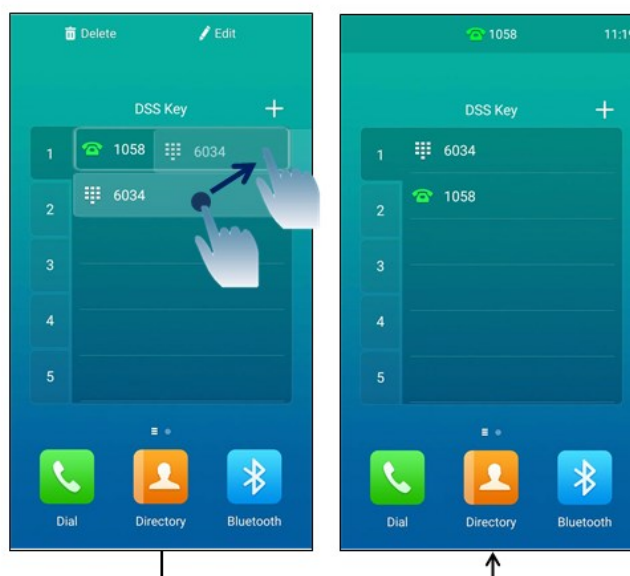

Deleting a Line Key

To delete a line key:

1. Tap the desired page key if required.
2. Drag the desired line key to the **Delete** field.

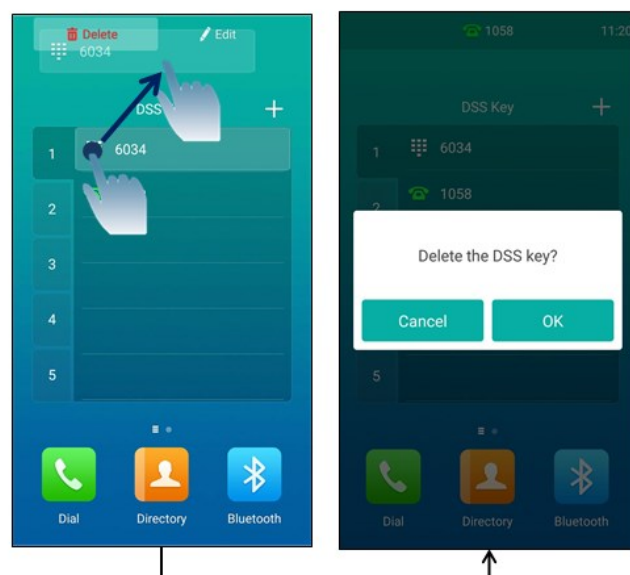

3. Tap **OK** to accept the change or **Cancel** to cancel.

Page Tips

The line key list can only display 6 line keys on one page. If the BLF monitored user receives an

incoming call on non-current page, you may miss the call because there is no notification on the current page.

You can use page tips feature to enable the page icon to indicate the status changes of particular feature (e.g., BLF) assigned to the line key on the non-current page. You can tap the desired page key to view the line key, and the page icon disappears.

Note The page icon may differ in color. For more information, contact your system administrator.

The following figure shows that there is a status change on the line key of first page:

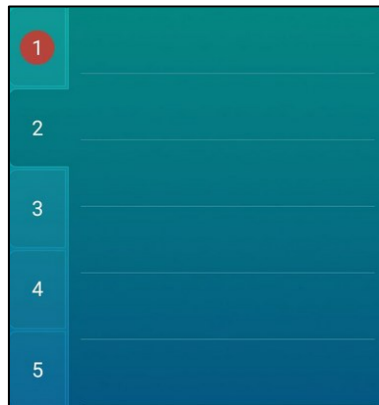

To configure the page tips feature via web user interface:

1. Click on **DSSKey**->**Line key**.
2. Select **Enabled** from the pull-down list of **Enable Page Tips**.

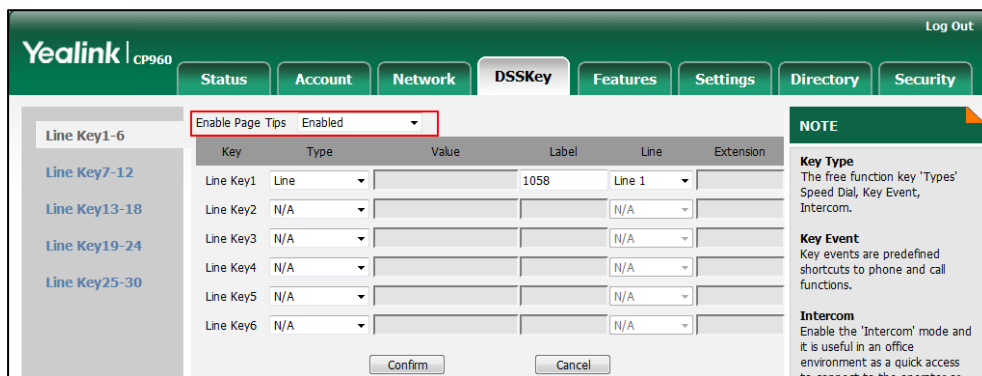

3. Click **Confirm** to accept the change.

Note Page tips feature is configurable via web user interface only.

Line Key Features

Line key features are explained in the following subchapters in detail:

- Line

- Voice Mail
- Direct Pickup
- Group Pickup
- DTMF
- Prefix
- Local Group
- XML Group
- XML Browser
- LDAP
- Forward
- DND
- Zero Touch
- URL
- Phone Lock
- Directory
- Mobile Account

For the features not listed above, refer to [Basic Phone Features](#) on page 138 and [Advanced Phone Features](#) on page 180. For more information, contact your system administrator.

Line

You can use this key feature to accept incoming calls, place active calls on hold or resume a held call.

Dependencies: *Type (Line)*

Account ID (the account this feature will be applied to)

Label (key label displayed on the touch screen)

Usage: When the phone receives an incoming call,

1. Tap the line key to accept the incoming call.
2. Tap the line key to place a new call and the active call is placed on hold.
3. Tap the line key again to resume the held call.

Voice Mail

You can use this key feature to quickly connect voice mail. For more information, refer to [Message](#) on page 221.

Dependencies: *Type (Key Event)*

Key Type (Voice Mail)

Account ID (the account this feature will be applied to)

Label (key label displayed on the touch screen)

Value (the voice mail access code)

Usage: Tap the voice mail key to dial out the voice mail access code. Then follow the voice prompt to listen to the voice mails.

Direct Pickup

You can use this key feature to answer someone else's incoming call on the phone.

Dependencies: *Type (Key Event)*

Key Type (*DPickup*)

Account ID (the account this feature will be applied to)

Label (key label displayed on the touch screen)

Value (the directed call pickup code followed by the target phone number)

Usage: Tap the direct pickup key on your phone when the target phone number receives an incoming call. The call is then answered on your phone.

Group Pickup

You can use this key feature to answer incoming calls in a group that is associated with their own group.

Dependencies: *Type (Key Event)*

Key Type (*GPickup*)

Account ID (the account this feature will be applied to)

Label (key label displayed on the touch screen)

Value (the group pickup code)

Usage: Tap the group pickup key on your phone when a phone number in the group receives an incoming call. The call is answered on your phone.

DTMF

You can use this key feature to send the specification of arbitrary key sequences via DTMF.

Dependencies: *Type (Key Event)*

Key Type (*DTMF*)

Label (key label displayed on the touch screen)

Value (*DTMF sequence*)

Usage: Tap the DTMF key during an active call to send the key sequence specified in the **Value** field.

Note

DTMF sequence can only contain "0-9", "*", "#", and "A-D".

Prefix

You can use this key feature to add a specified prefix number before the dialing number.

Dependencies: *Type (Key Event)*

Key Type (Prefix)

Label (key label displayed on the touch screen)

Value (the prefix number)

Usage: Tap the prefix key from the DSS key screen, the phone will then enter the dialing screen and display the prefix number that you specified in the **Value** field. You can enter the remaining digits and then dial out.

Local Group

You can use this key feature to quickly access a contact group in the local directory. For more information, refer to [Local Directory](#) on page 83.

Dependencies: *Type (Key Event)*

Key Type (Local Group)

Local Group (the contact group name you want to access)

Label (key label displayed on the touch screen)

Usage: Tap the local group key to access the contact group specified in the **Local Group** field.

XML Group

You can use this key feature to quickly access a remote group in your remote phone book. You should configure a remote phone book in advance. For more information, refer to [Remote Phone Book](#) on page 95.

Dependencies: *Type (Key Event)*

Key Type (XML Group)

PhoneBook Name (the remote group name you want to access if the remote phone book is configured)

Label (key label displayed on the touch screen)

Usage: Tap the XML group key to access the remote group specified in the **XML Group** field.

XML Browser

You can use this key feature to quickly access an XML browser. The XML browser allows you to create custom services which meet your functional requirements on the server. You can customize practical applications, such as weather report, stock information, Google search, etc.

Dependencies: *Type (Key Event)*

Key Type (XML Browser)

Label (key label displayed on the touch screen)

Value (the access URL for XML browser)

Usage: Tap the XML Browser key to access the XML browser specified in the **Value** field.

LDAP

You can use this key feature to quickly access a LDAP search screen.

Dependencies: Type (Key Event)**Key Type (LDAP)****Label** (key label displayed on the touch screen)**Usage:**

1. Tap the LDAP key to access the LDAP search screen.
2. Enter a few continuous characters of the contact name or continuous numbers of the contact number.

The contacts whose name or phone number matches the characters entered will appear on the touch screen.

Forward

You can use this key feature to forward an incoming call to someone else. For more information, refer to [Forwarding Incoming Calls](#) on page 146.

Dependencies: Type (Key Event)**Key Type (FWD)****Label** (key label displayed on the touch screen)**Value** (the number you want to forward to)

Usage: Tap the forward key to forward an incoming call to the number specified in the **Value** field.

Note

If the **Value** field is left blank, the forward key performs the same function as  when receiving an incoming call.

DND

You can use this key feature to enable or disable DND. You can also use this key feature to access the custom DND screen. For more information, refer to [Rejecting Calls with Do Not Disturb \(DND\)](#) on page 144.

Dependencies: Type (Key Event)**Key Type (DND)****Label** (key label displayed on the touch screen)**Usage:**

When DND is in phone mode:

1. Tap the DND key to enable DND.
2. Tap the DND key again to disable DND.

When DND is in custom mode:

1. Tap the DND key to access the custom DND screen. You can enable or disable DND for one or all accounts.

Zero Touch



You can use this key feature to quickly configure auto provision and network parameters.

Dependencies: *Type (Key Event)*

Key Type (Zero Touch)

Label (key label displayed on the touch screen)

Usage:

1. Tap the zero touch key to access the zero touch screen.
2. Tap Update within a few seconds.
3. Configure the network parameters in the corresponding fields.
4. Tap .
5. Configure the auto provision parameters in the corresponding fields.
6. Tap .

The phone will reboot to update configurations.

URL

You can use this key feature to trigger the phone to send an HTTP GET request containing a specific URL.

Dependencies: *Type (URL)*

Label (key label displayed on the touch screen)

URL (the URL contained in the HTTP GET request)

Usage: Tap the URL key to trigger the phone to send an HTTP GET request containing the URL specified in the **URL** field.

Phone Lock

You can use this key feature to immediately lock your phone. For more information, refer to [Phone Lock](#) on page 71.

Dependencies: *Type (Key Event)*

Key Type (Phone Lock)

Label (key label displayed on the touch screen)

Usage: When the phone lock feature is enabled, tap the phone lock key to immediately lock your phone.

Directory

You can use this key feature to easily access frequently used lists. For more information, refer to [Local Directory](#) on page 83.

Dependencies: *Type (Key Event)*

Key Type (Directory)

Label (key label displayed on the touch screen)

Usage: Tap the directory key to immediately access frequently used lists.

Note

The directory key performs the same function as the

**Mobile Account**

You can use this key feature to accept incoming mobile calls, place active mobile calls on hold on your IP phone. For more information, refer to [Connecting a Mobile Phone Using Bluetooth](#) on page 226.

Dependencies: *Type (Mobile Account)*

Label (key label displayed on the touch screen)

Usage: When the IP phone receives an incoming mobile call,

1. Tap the mobile account key to accept the incoming call.
2. Tap the mobile account key to place a new call and the active call is placed on hold.

Account Management

You can register only one account on the CP960 IP phone. You can also configure each line key to associate with an account or configure multiple line keys to associate with an account.

Account Registration

To register an account via phone user interface:

1. Tap **Settings** from the Home screen.
2. Enter the admin password (default password: admin) from the **Advanced** block.
3. Tap **Accounts**.
4. Tap the desired account.
5. Tap the **Activation** field.
6. Tap **Enabled** in the pop-up dialog box.

7. Enter the desired value in the **Label**, **Display Name**, **Register Name**, **User Name**, **Password** and **SIP Server1/2** field respectively. Contact your system administrator for more information.

The screenshot shows a mobile application interface titled "Accounts". It contains a list of configuration fields:

- 1. Activation: Enabled
- 2. Label: 1058
- 3. Display Name: 1058
- 4. Register Name: 1058
- 5. User Name: 1058
- 6. Password:
- 7. SIP Server1: 10.2.1.48
- 8. SIP Server2: (empty)
- 9. Outbound Status: Disabled

8. If you use the outbound proxy servers, do the following:
 - 1) Tap the **Outbound Status** field.
 - 2) Tap **Enabled** in the pop-up dialog box.
 - 3) Enter the desired value in the **Outbound Proxy1/2** and **Fallback Interval** field respectively. Contact your system administrator for more information.
9. Tap to accept the change or to cancel.

You can repeat steps 3 to 8 to register more accounts.

To disable an account via phone user interface:

1. Tap **Settings** from the Home screen.
2. Enter the admin password (default password: admin) from the **Advanced** block.
3. Tap **Accounts**.
4. Tap the desired account.
5. Tap the **Activation** field.
6. Tap **Disabled** in the pop-up dialog box.
7. Tap to accept the change or to cancel.

Account registration is configurable via web user interface at the path **Account->Register**.

Multiple Line Keys per Account

You can configure multiple line keys to associate with an account. This enhances call visualization and simplifies call handling.

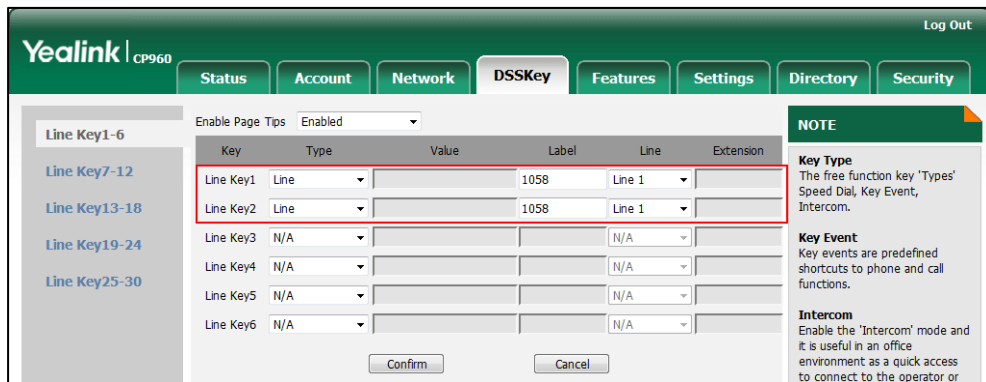

If this is the case, the touch screen will resemble the following figure:

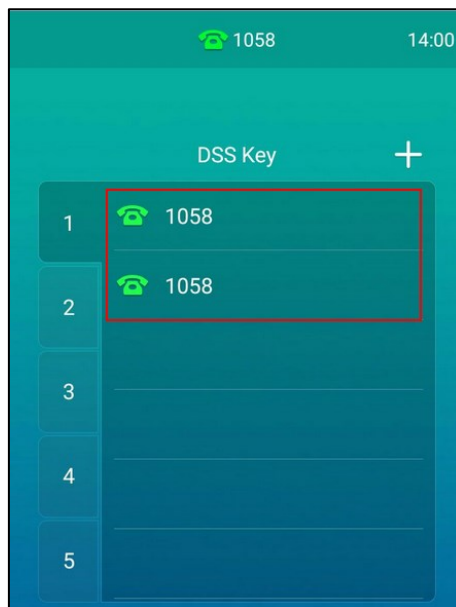

Incoming calls to this account will be distributed evenly among the available line keys. Outgoing calls will be distributed similarly.

Your phone can be configured to have a combination of accounts with a single line key and accounts with multiple line keys.

Dial Plan

Dial plan is a string of characters that governs the way your CP960 IP phone processes the inputs received from your onscreen dial pad. The CP960 IP phone supports the following dial plan features:

- [Replace Rule](#)

- [Dial-now](#)
- [Area Code](#)
- [Block Out](#)

Basic expression syntaxes you need to know:

.	The dot "." can be used as a placeholder or multiple placeholders for any character. Example: "12." would match "123", "1234", "12345", "12abc", etc.
x	An "x" can be used as a placeholder for any character. Example: "12x" would match "121", "122", "123", "12a", etc.
-	Numeric ranges are allowed within the brackets: Digit "-" Digit. Example: "[5-7]" would match the number "5", "6" or "7".
[]	The square brackets "[]" can be used as a placeholder for a single character which matches any of a set of characters. Example: "91[5-7]1234" would match "9151234", "9161234", "9171234".
()	The parentheses "(")" can be used to group together patterns, for instance, to logically combine two or more patterns. Example: "([1-9])([2-7])3" would match "923", "153", "773", etc.
\$	The "\$" should be followed by the sequence number of a parenthesis. The "\$" plus the sequence number means the whole character or characters placed in the parenthesis. The number directs to the right parenthesis when there are more than one. Example: A replace rule configuration, Prefix: "001(xxx)45(xx)", Replace: "9001\$145\$2". When you dial out "0012354599" on your phone, the IP phone will replace the number with "9001 2354599 ". "\$1" means 3 digits in the first parenthesis, that is, "235". "\$2" means 2 digits in the second parenthesis, that is, "99".

Note

The IP phone supports a new dial plan mechanism - digit map. Digit maps are defined by a single string or a list of strings. If a number you dial matches any string of a digit map, the call is automatically placed.

Note that if digit map feature is enabled, the old dial plan rules (described in this chapter) will be ignored. For more information, contact your system administrator.

Replace Rule

You can configure one or more replace rules (up to 100) to remove the specified string and replace it with another string. You can configure a pattern with wildcards (refer to the expression syntax in the table above), so that any string that matches the pattern will be replaced. This feature is convenient for you to dial out a long number. For example, a replace rule is configured as "Prefix: 1" and "Replace: 1234", when you try to dial out the number "1234", you just need to enter "1" on the phone and then tap **Send**.

To add a replace rule via web user interface:

1. Click on **Settings->Dial Plan->Replace Rule**.
2. Enter the string (e.g., 1) in the **Prefix** field.
3. Enter the string (e.g., 1234) in the **Replace** field.
4. Enter the desired line ID in the **Account** field or leave it blank.

5. Click **Add** to add the replace rule.
When you enter the number "1" and then tap **Send**, the phone will dial out "1234" instead.

Note

If you leave the **Account** field blank or enter 0, the replace rule will apply to all accounts.

To edit a replace rule via web user interface:

1. Click on **Settings->Dial Plan->Replace Rule**.
2. Select the desired replace rule by checking the checkbox.
3. Edit the values in the **Prefix** and **Replace** fields.
4. Enter the desired line ID in the **Account** field or leave it blank.
5. Click **Edit** to accept the change.

To delete one or more replace rules via web user interface:

1. Click on **Settings->Dial Plan->Replace Rule**.
2. Select one or more replace rules by checking the checkbox(es).
3. Click **Del** to delete the replace rule(s).

Dial-now

You can configure one or more dial-now rules (up to 100) on your phone. When the dialed number matches the dial-now string, the number will be dialed out automatically. For example, a dial-now rule is configured as "2xx", any entered three-digit string beginning with 2 will then

be dialed out automatically on the phone.

To add a dial-now rule via web user interface:

1. Click on **Settings->Dial Plan->Dial-now**.
2. Enter the desired value (e.g., 2xx) in the **Rule** field.
3. Enter the desired line ID in the **Account** field or leave it blank.

For more information on the valid values for the **Account** field, refer to [Replace Rule](#) on page 116.

The screenshot shows the Yealink CP960 web interface. The 'Settings' tab is active, and the 'Dial Plan' section is selected. The 'Dial-now' sub-tab is active, displaying a table with columns for Index, Dial-now Rule, Area Code, and Block Out. Below the table, there are input fields for 'Rule' (containing '2xx') and 'Account'. The 'Add' button is highlighted with a red box. A 'NOTE' section on the right provides information about digit ranges and symbols used in the rules.

Index	Dial-now Rule	Area Code	Block Out
1			<input type="checkbox"/>
2			<input type="checkbox"/>
3			<input type="checkbox"/>
4			<input type="checkbox"/>
5			<input type="checkbox"/>
6			<input type="checkbox"/>
7			<input type="checkbox"/>
8			<input type="checkbox"/>
9			<input type="checkbox"/>
10			<input type="checkbox"/>

NOTE

Digit 0-9 *
Identifies a specific digit; (do not use # if it is defined as send key).

[digit-digit]
Identifies any digit dialed that is included in the range.

[digit-digit,digit]
Specifies a range as a comma separated list.

x
Matches any single digit/character which is dialed.

.
Matches an arbitrary number of digits.

You can click here to get more guides.

4. Click **Add** to add the dial-now rule.

When you enter the number "234", the phone will dial out "234" automatically without the tapping of any key.

Note

You can also edit or delete the dial-now rule, refer to [Replace Rule](#) on page 116 for more information.

Delay Time for Dial-Now Rule

You can configure the delay time for dial-now rules. That is, you can configure your phone to automatically dial out the phone number which matches a dial-now rule, after the designated delay time.

To configure the delay time for dial-now rule via web user interface:

1. Click on **Features->General Information**.

- Enter the time between 0 and 14 (seconds) in the **Time-Out for Dial-Now Rule** field.
The default value is "1".

The screenshot shows the Yealink CP960 web interface. The 'Features' tab is selected, and the 'General Information' section is visible. The 'Time-Out for Dial-Now Rule' field is highlighted with a red box and contains the value '1'. Other fields include Call Waiting (Enabled), Auto Redial (Disabled), and RFC 2543 Hold (Disabled).

Field	Value
Call Waiting	Enabled
Call Waiting On Code	
Call Waiting Off Code	
Auto Redial	Disabled
Auto Redial Interval (1~300s)	10
Auto Redial Times (1~300)	10
Reserve # in User Name	Enabled
Hotline Number	
Hotline Delay(0~10s)	4
Busy Tone Delay (Seconds)	0
Return Code When Refuse	486 (Busy Here)
Return Code When DND	480 (Temporarily Unavailable)
Call Completion	Disabled
Feature Key Synchronization	Disabled
Time-Out for Dial-Now Rule	1
RFC 2543 Hold	Disabled
Use Outbound Proxy In Dialog	Enabled

- Click **Confirm** to accept the change.

Note Delay time for dial-now rule is configurable via web user interface only.

Area Code

Area codes are also known as Numbering Plan Areas (NPAs). They usually indicate geographical areas in a country. This feature is necessary when dialing a phone number outside the code area. For example, an area code is configured as "Code: 0592, Min Length: 1, Max Length: 15". When you dial out the number "56789" (the length of the number is between 1 and 15), the phone will add the area code and dial out the number "059256789". You can only configure one area code rule on your phone.

To configure the area code and lengths via web user interface:

- Click on **Settings->Dial Plan->Area Code**.
- Enter the desired values in the **Code**, **Min Length (1-15)** and **Max Length (1-15)** fields.
- Enter the desired line ID in the **Account** field or leave it blank.

For more information on the valid values for the **Account** field, refer to [Replace Rule](#) on page 116.

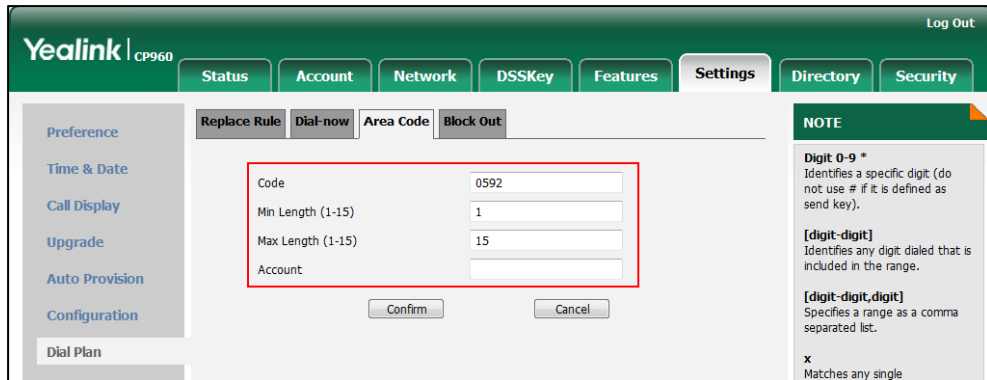

4. Click **Confirm** to accept the change.

Note The default value of minimum and maximum length is 1 and 15 respectively.

Block Out

You can block some specific numbers (up to 10) from being dialed on your phone. When you dial a block out number on your phone, the dialing will fail and the touch screen will prompt "Forbidden Number".

To add a block out number via web user interface:

1. Click on **Settings->Dial Plan->Block Out**.
2. Enter the desired value in the **BlockOut Number** field.
3. Enter the desired line ID in the **Account** field or leave it blank.

For more information on the valid values for the **Account** field, refer to [Replace Rule](#) on page 116.

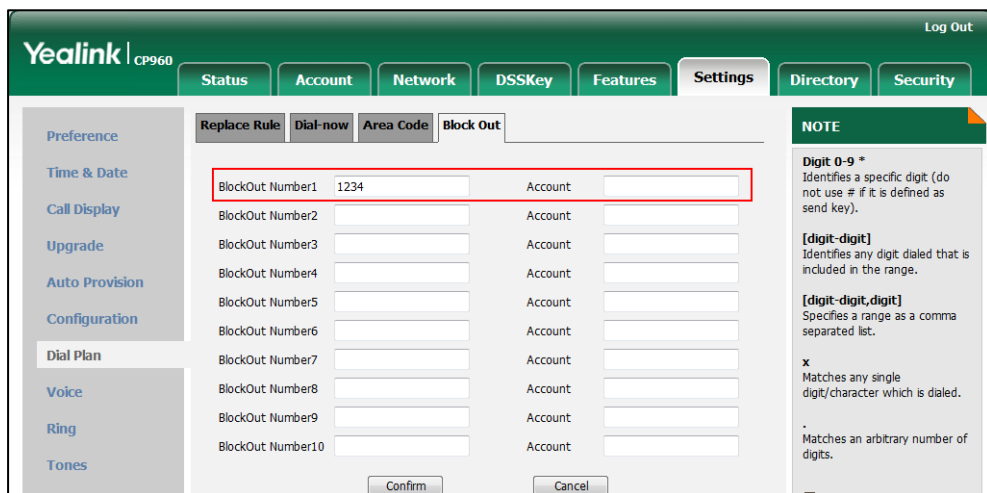

4. Click **Confirm** to add the block out number.

Emergency Number

Public telephone networks in countries around the world have a single emergency telephone number (emergency services number), that allows a caller to contact local emergency services for assistance when necessary. The emergency telephone number may differ from country to country. It is typically a three-digit number so that it can be easily remembered and dialed quickly. Some countries have a different emergency number for each of the different emergency services.

You can specify the emergency telephone numbers on the IP phone for contacting the emergency services in an emergency situation. You can dial these numbers when the phone is locked. For more information on phone lock refer to [Phone Lock](#) on page 71.

Note

Contact your local phone service provider for available emergency numbers in your area.

The IP phone also supports the emergency dialplan, which allows users to make emergency calls if the phone is locked or unregistered. For more information, contact your system administrator.

To specify emergency numbers via web user interface:

1. Click on **Features->Phone Lock**.
2. Enter the emergency number in the **Emergency** field.

For multiple emergency numbers, enter a comma between every two numbers. The default emergency numbers are 112, 911 and 110.

The screenshot shows the Yealink T58 web interface. The 'Features' tab is selected, and the 'Phone Lock' sub-tab is active. The 'Emergency' field is highlighted with a red box and contains the text '112,911,110'. Other fields include 'Phone Lock Enable' (set to 'Enabled'), 'Phone Unlock PIN(0~15 Digit)' (masked with dots), and 'Phone Lock Time Out(0~3600s)' (set to '0'). There are 'Confirm' and 'Cancel' buttons at the bottom. A 'NOTE' box on the right contains the text: 'Phone Lock: The phone lock parameters for administrator. You can click here to get more guides.'

3. Click **Confirm** to accept the change.

Note

Emergency number is configurable via web user interface only.

Live Dialpad

You can enable live dialpad on the CP960 IP phone, which enables the IP phone to automatically dial out a phone number without tapping the send key. You can also configure a delay, where the phone will dial out the phone number automatically after the designated period of time.

To enable the live dialpad via web user interface:

1. Click on **Settings**->**Preference**.
2. Select **Enabled** from the pull-down list of **Live Dialpad**.
3. Enter the desired delay time in the **Inter Digit Time(1~14s)** field.

The default delay time is 4.

The screenshot shows the 'Preference' settings page for a Yealink CP960 IP phone. The 'Live Dialpad' option is set to 'Enabled' and the 'Inter Digit Time(1~14s)' field is set to '4'. A red box highlights these two fields. The page includes a sidebar with navigation options like 'Preference', 'Time & Date', 'Call Display', 'Upgrade', 'Auto Provision', 'Configuration', 'Dial Plan', 'Voice', 'Ring', 'Tones', and 'TR069'. The 'NOTE' section on the right states: 'Preference Settings: The preference settings for administrator. You can click here to get more guides.'

4. Click **Confirm** to accept the change.

Note Live dialpad is configurable via web user interface only.

Hotline

You can dial a hotline number immediately upon tapping /desired line key. You can also configure a delay, where the phone will dial out the hotline number automatically after a designated period of time.

To configure the hotline number via phone user interface:

1. Tap **Settings** from the Home screen.
2. Tap **Hot Line** from the **Features** block.
3. Enter the desired number in the **Number** field.
4. Enter the desired delay time in the **Hotline Delay** field.

The default value is 4.

5. Tap to accept the change or to cancel.

Hotline is configurable via web user interface at the path **Features->General Information**.

FWD International

You can use FWD international feature to forward an incoming call to an international telephone number (the prefix is 00). For more information on call forward, refer to [Forwarding Incoming Calls](#) on page 146.

To configure the FWD international via phone user interface:

1. Tap **Settings** from the Home screen.
2. Enter the admin password (default password: admin) from the **Advanced** block.
3. Tap **FWD International**.
4. Tap the **FWD International** field.
5. Tap **Enabled** in the pop-up dialog box.

6. Tap to accept the change or to cancel.

FWD International is configurable via web user interface at the path **Features->General Information**.

System Applications

The system applications are pre-installed on your phone and they cannot be uninstalled.

This chapter provides basic operating instructions for using the system applications. Topics include:

- [Recorder](#)
- [Browser](#)
- [Clock](#)

Recorder

You can use **Recorder** application to record audios and manage the recorded audios.

During recording, you can mark specific moments so that you can quickly find and listen to them later. The recorded audios are saved with the name consisting of a prefix "record@" and date & time stamp, for example, record@20170517-092310 was created on May 17, 2017, at 09:23:10.

Note



The recorded audios are saved in *.amr format, and you can record up to 12 hours in one file. You can play the recorded audios on either the phone itself or on a computer using an application capable of playing *.amr files.

Before recording any call, especially those involving PSTN, it is necessary to know about the rules and restrictions of any governing call-recording in the place you are in. It is also very important to have the consent of the person you are calling before recording the conversation.



Recording Audios

By default, the recorded audios are saved in the internal SD card. You can connect a USB flash drive to your phone, and save the recorded audios to it. For more information on how to connect a USB flash drive, refer to [Connect the Optional USB Flash Drive](#) on page 29.

To record an audio:



1. Tap  to launch **Recorder** application.
2. If you want to save the recorded audio to USB flash drive, tap  .
It appears only if you connect a USB flash drive.
3. Tap  to start recording.

4. You can do one of the following:

- Tap  to pause the recording, and then tap  to resume the recording.
- Tap  to set a mark.

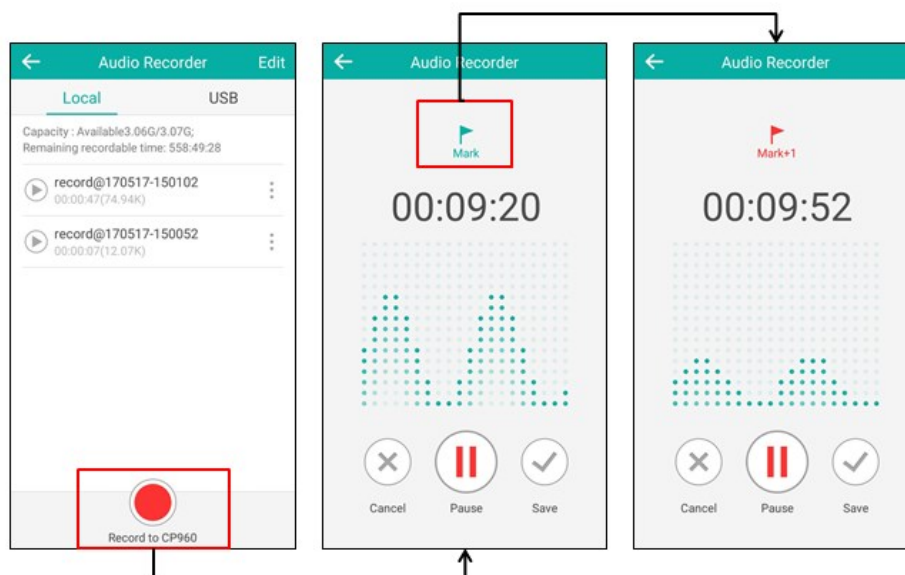
The icon changes to , the number will increase if you set more marks. And there is a red flag on this moment when playing the recorded audio.





5. Tap  to end the recording and save the recorded audio, or tap  to cancel the recording.

The recorded audio displays on the list automatically.



Playing the Recorded Audios

When you receive an incoming call while playing a recording, the recording is paused automatically. If you do not answer or reject the incoming call, or if you answer the incoming call and end the call, the recording will continue to play automatically.

To play the recorded audio:

1. Tap  to launch **Recorder** application.
2. If you want to play the recorded audio saved in USB flash drive, tap .
3. Tap  before the desired recorded audio to play the recorded audio.

During the playing, you can do the following:

- Tap  to pause the playing.
To continue the playing, tap .
- Drag the slider to skip forward the playing or rewind the playing.
- Drag the slider to the position with red flag to listen to the marked moments.

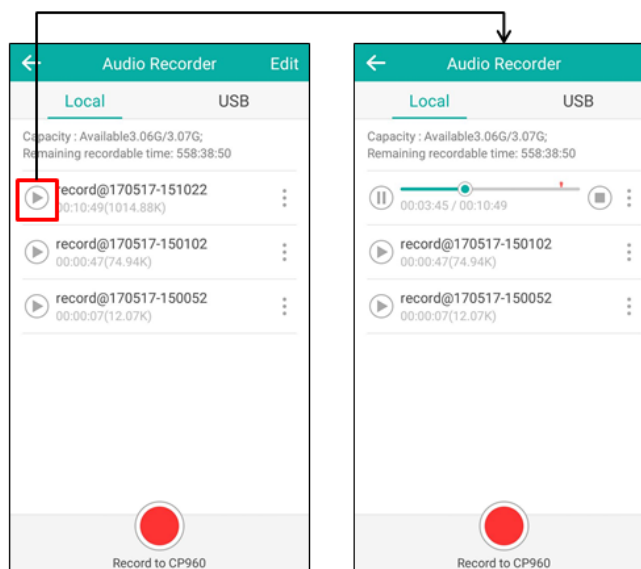

- Tap one of the Volume touch key to increase or decrease the volume of the speakerphone.
- Tap  to stop the playing.



Copying Recorded Audios to USB Flash Drive

Before copying recorded audios to USB flash drive, you should connect a USB flash drive first. For more information on how to connect a USB flash drive, refer to [Connect the Optional USB Flash Drive](#) on page 29.

To copy a recorded audio to USB flash drive:

1. Tap  to launch **Recorder** application.
2. Tap  after the desired recorded audios.
3. Tap **Copy to USB**.

If the recorded audio is copied successfully, the touch screen will prompt “Copy successfully”.

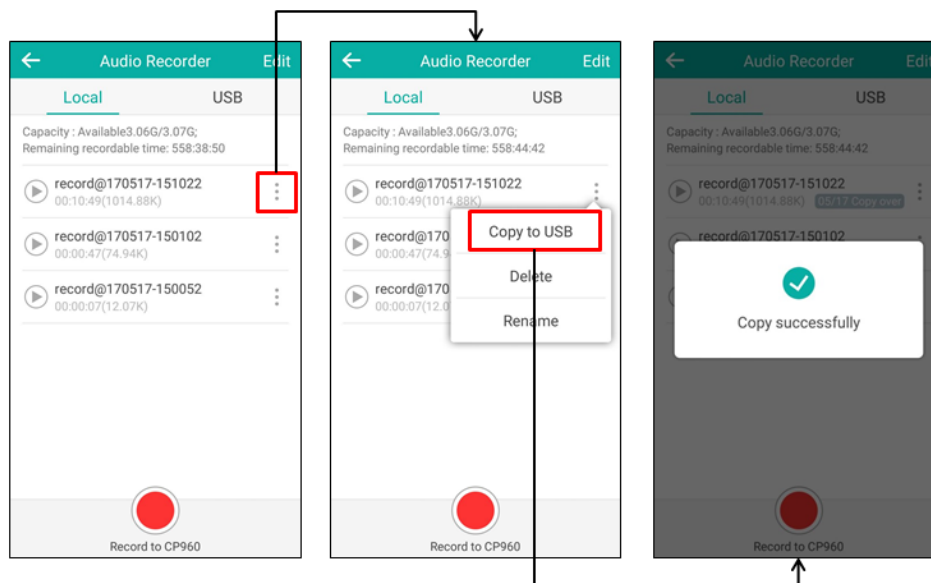

The prompt “XX Copied” (XX indicates the date when the recorded audio is copied to the USB flash drive) appears under the corresponding recorded audio.

To copy all recorded audios to USB flash drive:

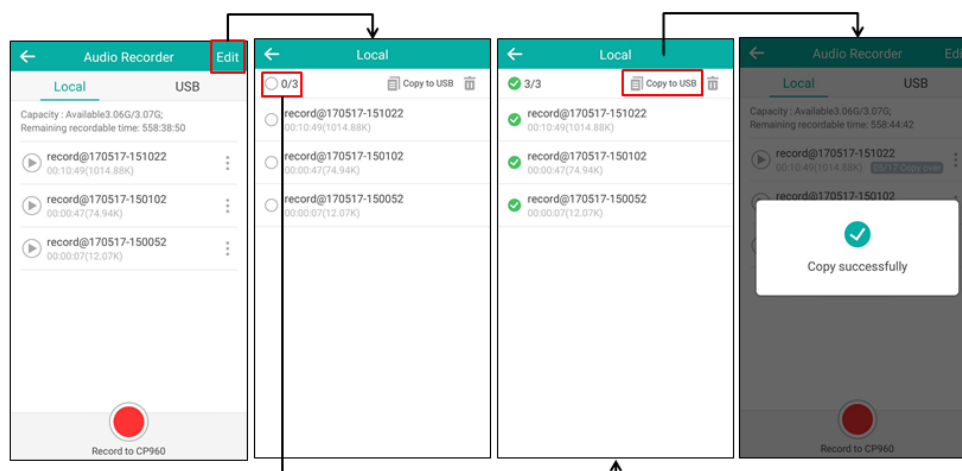

1. Tap  to launch **Recorder** application.
2. Tap **Edit**.
3. Tap the radio box on the top-left of the screen to select all recordings.
4. Tap **Copy to USB**.



The prompt “XX Copied” (XX indicates the date when the recorded audio is copied to the USB flash drive) appears under the corresponding recorded audio.

Renaming the Recorded Audios

To rename a recorded audio:

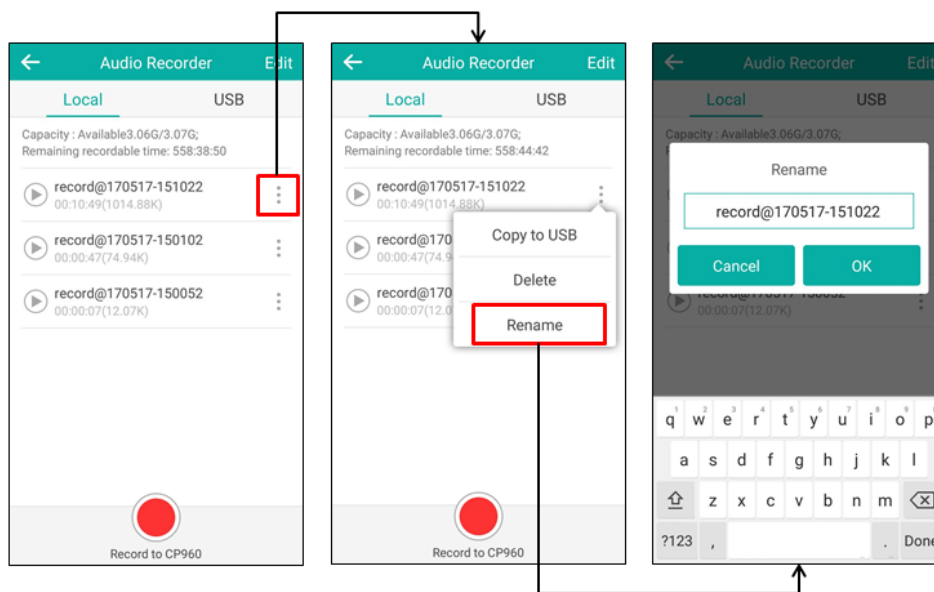

1. Tap  to launch **Recorder** application.
2. If you want to rename the recorded audio saved in USB flash drive, tap .
3. Tap  after the desired recorded audios.
4. Tap **Rename**.



5. Enter the desired file name.
6. Tap **OK** to accept the change or **Cancel** to cancel.

Deleting the Recorded Audios

To delete a recorded audio:

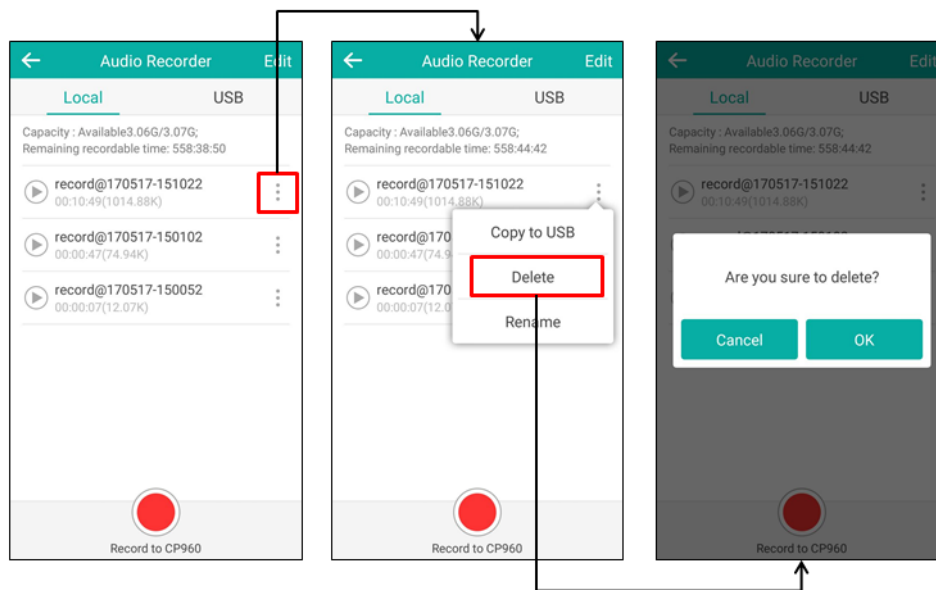

1. Tap  to launch **Recorder** application.
2. If you want to delete the recorded audio saved in USB flash drive, tap .
3. Tap  after the desired recorded audio.

4. Tap **Delete** to delete the recorded audio.



5. Tap **OK** to accept the change or **Cancel** to cancel.

To delete all recorded audios:

1. Tap  to launch **Recorder** application.
2. If you want to delete the recorded audios saved in USB flash drive, tap .
3. Tap **Edit**.
4. Tap the radio box on the top-left of the screen to select all recordings.
5. Tap .

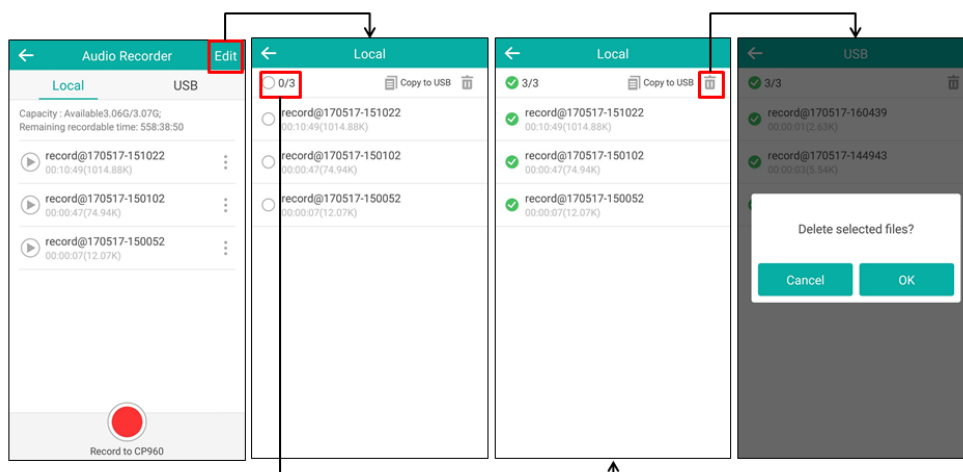



6. Tap **OK** to accept the change or **Cancel** to cancel.

Checking Storage Space

You can check the storage space (e.g., total space, available space) of the IP phone or connected

USB flash drive. There must be enough free space (10M) on the IP phone or USB flash drive to record.

To check the storage space:

1. Tap  to launch **Recorder** application.
2. If you want to check the storage space of the USB flash drive, tap .

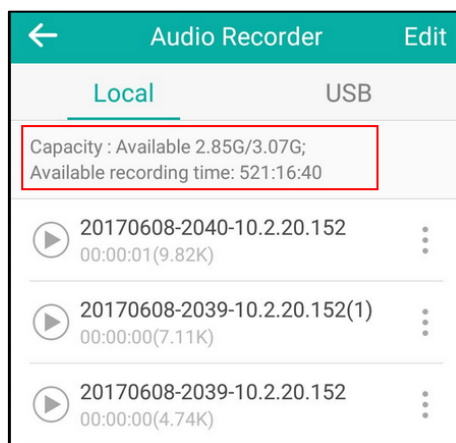

Browser

The **Browser** application could be used in a similar way as a PC-based web browser, i.e., browse web pages, bookmarks, set home pages, clear history and etc. The default home page is the Yealink website.

Browsing a Web Page

To browse a web page:

1. Tap  to launch **Browser** application.

2. Enter a part of URL in the address input field of the browser.
The phone will automatically retrieve and list similar websites.

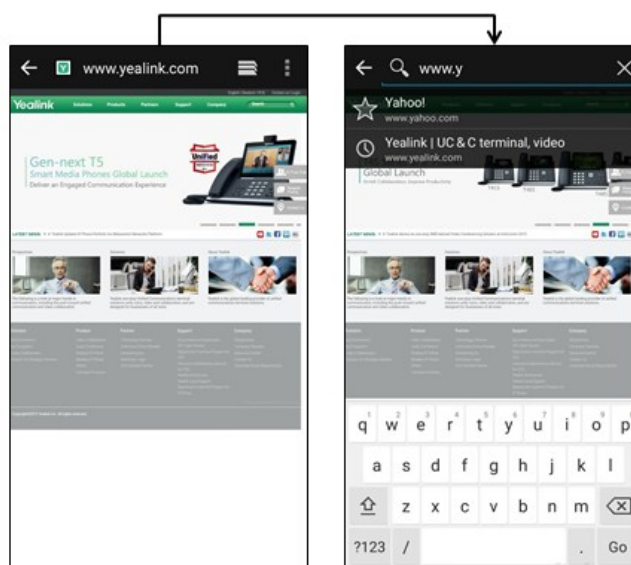



3. Tap the website you want to visit or enter the full URL then tap **Go** on the onscreen keyboard to browse the web page.
4. You can do the following:
 - Scroll up/down to view the web page.
 - Pinch open or pinch close the web page.

Managing Bookmarks

You can bookmark the web pages that you frequently visit.

To add a web page to the bookmarks list:

1. Tap  to launch **Browser** application.
2. Open the web page you want to bookmark.
3. Tap .

4. Tap **Save to bookmarks**.

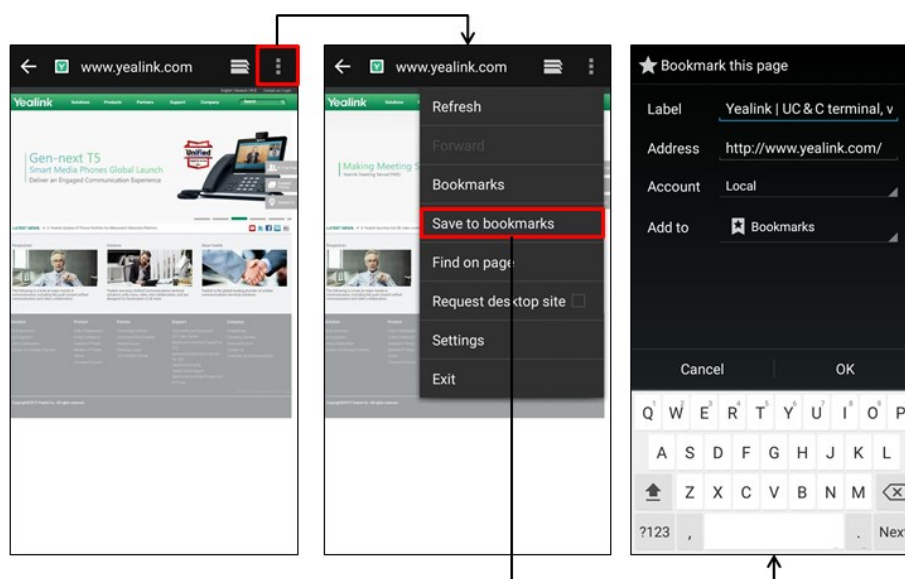

5. Edit the bookmark information in corresponding fields.

6. Tap **OK** to accept the change.

Then the web page is added to the **BOOKMARKS** list.

To open a web page from the bookmarks list:

1. Tap  to launch **Browser** application.

2. Tap  on the top-right of the screen.

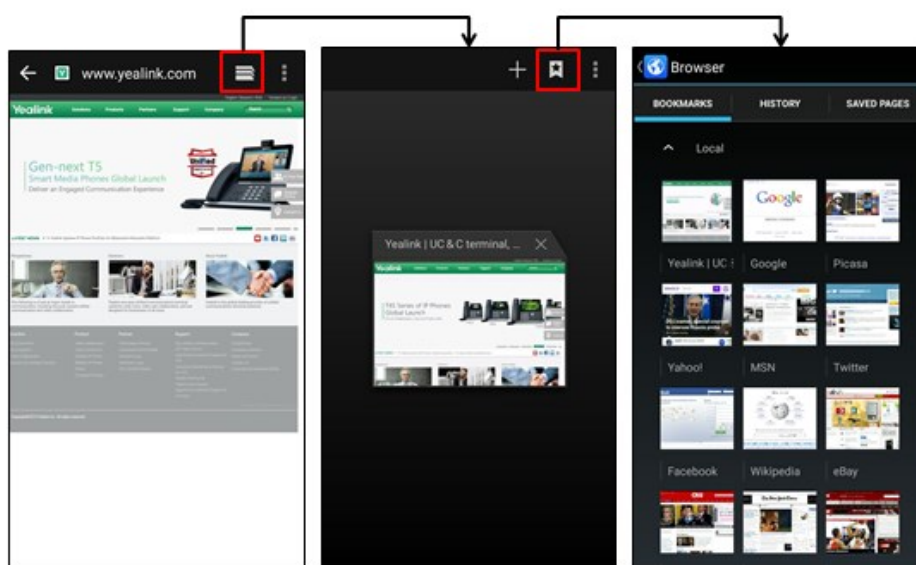

3. Tap  to access the **BOOKMARKS** list.

There are some pre-configured bookmarks.



4. Tap the web page you want to visit.

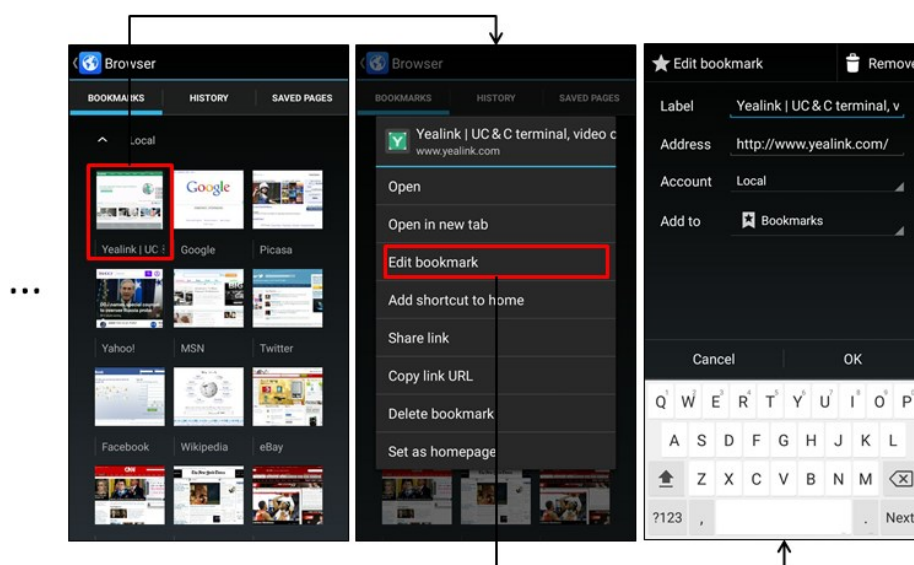

To edit a bookmark:

1. Tap  to launch **Browser** application.
2. Tap  on the top-right of the screen.
3. Tap  to access the **BOOKMARKS** list.
There are some pre-configured bookmarks.
4. Long tap the bookmark you want to edit.
5. Tap **Edit bookmark** in the pop-up dialog box.
6. Edit the bookmark.



7. Tap **OK** to accept the change or **Cancel** to cancel.



To delete a bookmark:

1. Tap  to launch **Browser** application.
2. Tap  on the top-right of the screen.
3. Tap  to access the **BOOKMARKS** list.
There are some pre-configured bookmarks.
4. Long tap the bookmark you want to delete.
5. Tap **Delete bookmark** in the pop-up dialog box.
6. Tap **OK** to accept the change or **Cancel** to cancel.

Setting a Home Page

You can set the web page you visit most frequently as the home page. Then, each time you open the browser, this web page is automatically opened.

To set a home page:

1. Tap  to launch **Browser** application.
2. Tap .
3. Tap **Settings**->**General**->**Set homepage**.

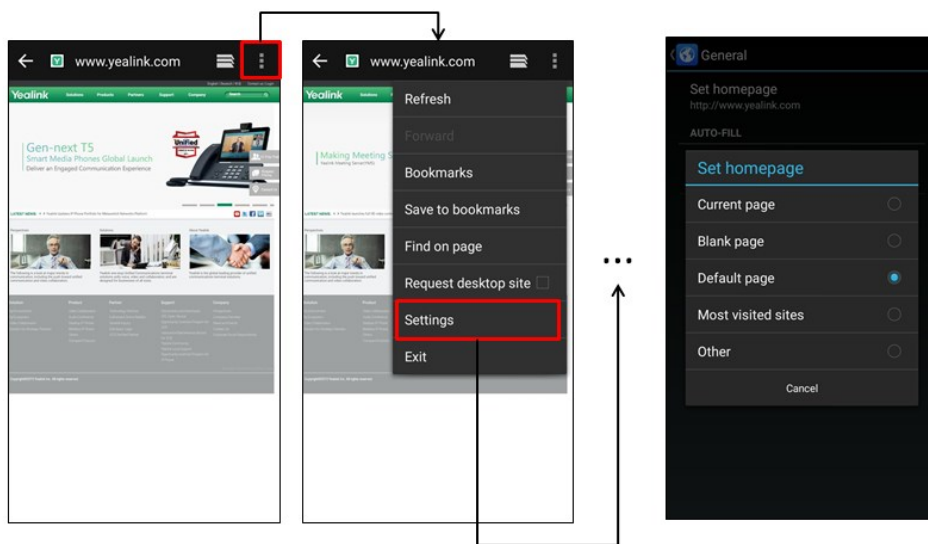



4. Tap the web page you want to set as the home page in the pop-up dialog box.
You can also long tap a web page in **BOOKMARKS** list and then tap **Set as homepage**.

Clearing the Navigation History

You can periodically clear your navigation history to protect your privacy and prevent information disclosure.

To clear the navigation history:

1. Tap  to launch **Browser** application.
2. Tap .

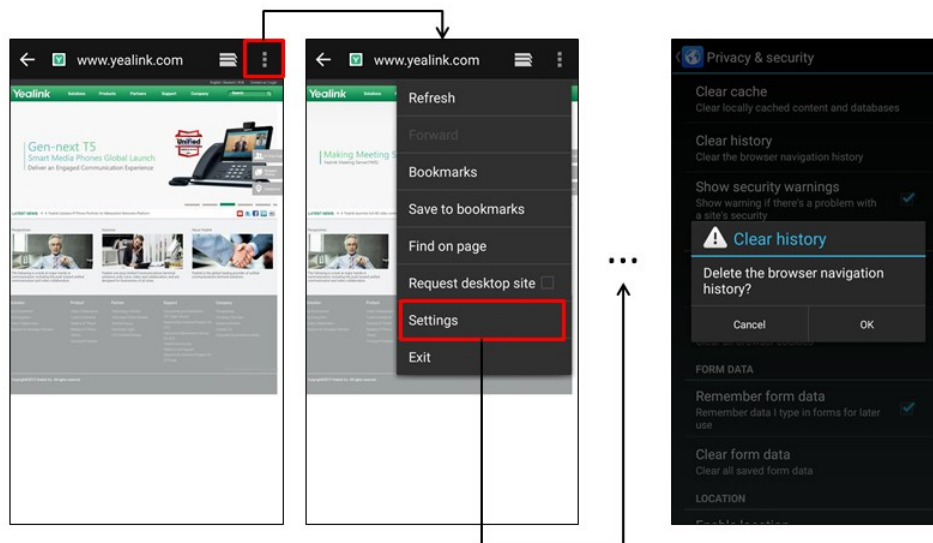

3. Tap **Settings**->**Privacy & security**->**Clear history**.



4. Tap **OK** to accept the change or **Cancel** to cancel.

Modifying Browser Settings

To modify browser settings:

1. Tap  to launch **Browser** application.
2. Tap .
3. Tap **Settings**.
4. Customize the browser style you prefer.

Clock

You can use the **Clock** application to check the time of other cities in the world.

To add the clock of other cities in the world:

1. Tap the digital clock from the Home screen.
There are some pre-configured clocks.
2. Tap .
3. Drag up and down to scroll through the cities.
4. Tap the checkbox(s) before the desired city.

5. Tap ← to return to the clock screen.

The added clock of the desired city displays on the touch screen.

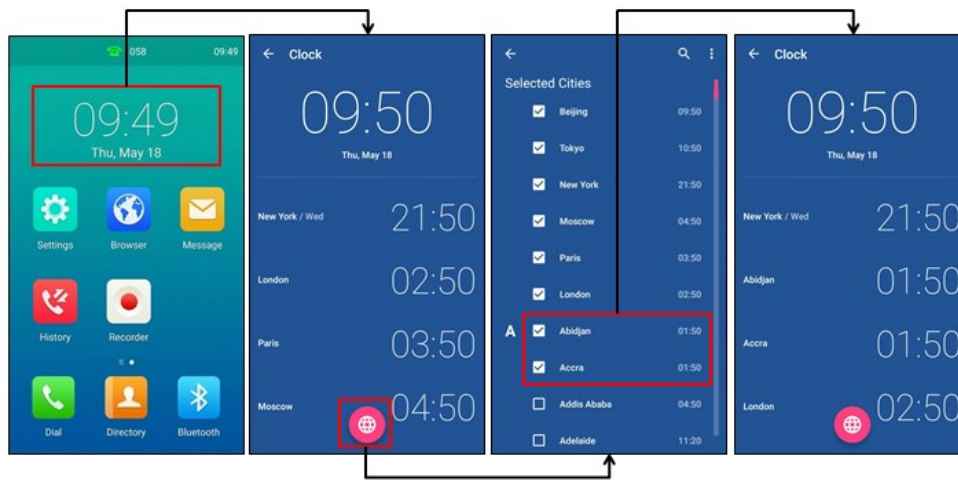

Basic Phone Features

The CP960 IP phone is designed to be easily used like a regular phone on a public switched telephone network (PSTN). You can place calls, answer calls, transfer a call to someone else, or conduct a conference call.

This chapter provides basic operating instructions for the CP960 IP phone. Topics include:

- [Placing Calls](#)
- [Answering Calls](#)
- [Handling Incoming Calls](#)
- [Ending Calls](#)
- [Speed Dial](#)
- [Recent Call In Dialing](#)
- [Auto Redial](#)
- [Call Completion](#)
- [Recall](#)
- [Call Mute/Unmute](#)
- [Call Hold/Resume](#)
- [Call Transfer](#)
- [Call Waiting](#)
- [Conference](#)
- [Call Park](#)
- [Call Pickup](#)
- [Anonymous Call](#)
- [Anonymous Call Rejection](#)

Placing Calls

You can place calls on the IP phone in numerous ways, including placing calls by dialing, placing calls from call history or placing calls to contacts. If you connect a mobile phone to your IP phone, you can also place calls over Bluetooth.

For more information, refer to [Contact Management](#) on page 82, [Connecting a Mobile Phone Using Bluetooth](#) on page 226 and [Call History Management](#) on page 99.

Placing a Call

To place a call:

1. Tap  .
2. Enter the desired number using the onscreen dial pad.

Tap  to see the onscreen keyboard, and then you can enter the number using the onscreen keyboard.

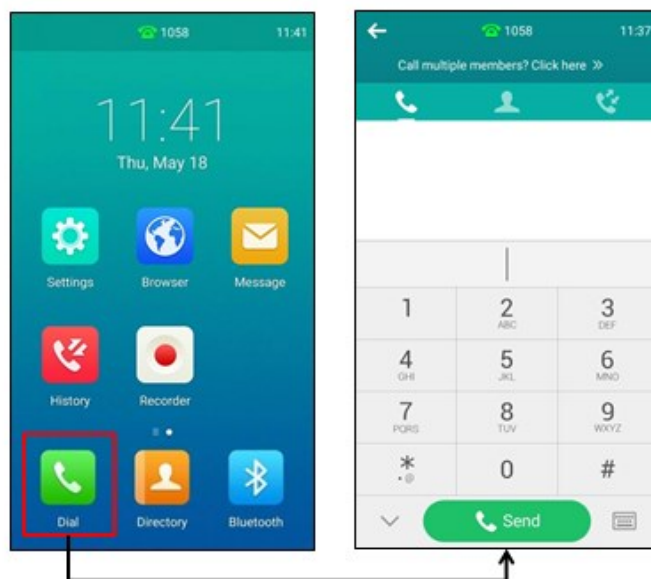

3. Tap **Send**.

Note

You can also dial using the SIP URI or IP address. To obtain the IP address of a phone, tap **Settings** and then tap **General** from the **Status** block. The maximum SIP URI or IPv4 address length is 32 characters. For example, SIP URI: 3606@sip.com, IP: 192.168.1.15.

Your phone may not support direct IP dialing. Contact your system administrator for more information.

Placing Multiple Calls

The CP960 IP phone can handle multiple calls at a time. However, only one active call (the call that has audio associated with it) can be in progress at any time. The CP960 IP phone can handle a maximum of 50 calls at one time.

To place multiple calls:

You can have more than one call on your CP960 IP phone. To place a new call during an active call:

1. Tap **More**->**NewCall**.
2. Enter the desired number using the onscreen dial pad.

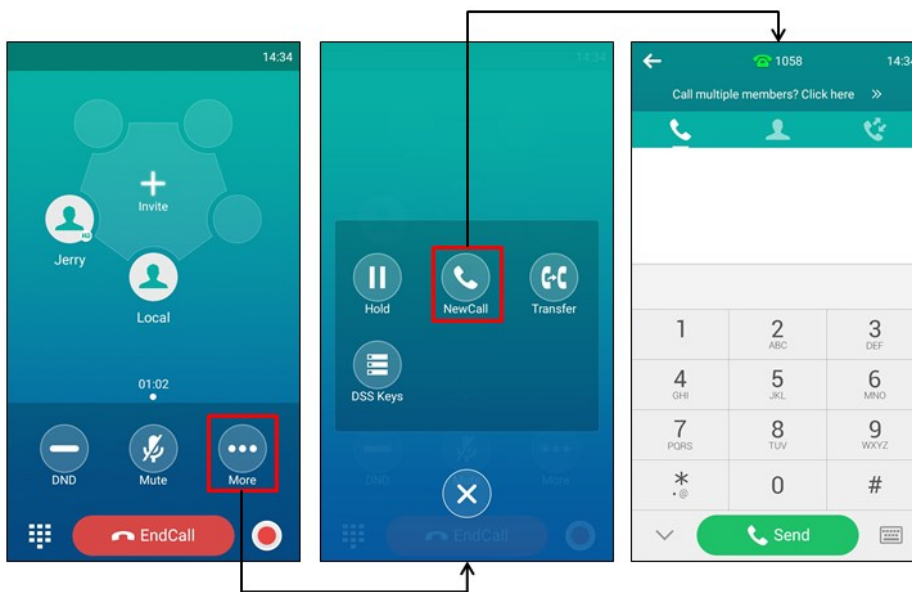

3. Tap **Send**.

Placing a Mobile Call over Bluetooth

If you connect a Bluetooth-Enabled mobile phone with your IP phone, you can place a mobile call on your mobile phone or IP phone. The IP phone screen and mobile phone screen both shows the connected call. You can use the IP phone as a hands free device for the call. You can use the IP phone to place both the mobile call and IP call, and two types of calls will not affect each other.

Before placing a mobile call over Bluetooth, you should enable the phone audio feature first. For more information, refer to [Making/Receiving a Mobile Call on the IP Phone](#) on page 229.

To place a mobile call over Bluetooth on your IP phone:

1. Connect a Bluetooth-Enabled mobile phone with your phone (refer to [Pairing and Connecting the Bluetooth-Enabled Mobile Phone](#)).

2. Do one of the following:
 - Tap the **My Mobile** line key.
Enter the desired number.

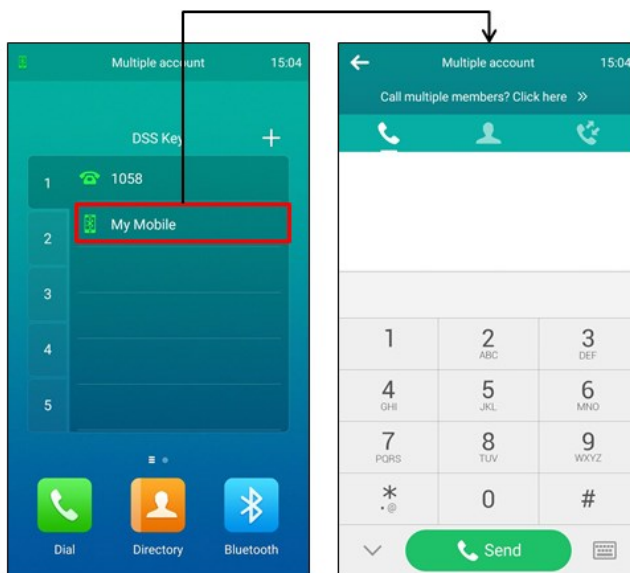

Tap **Send**.

- Tap .
Enter the desired number.
Tap **Send**.

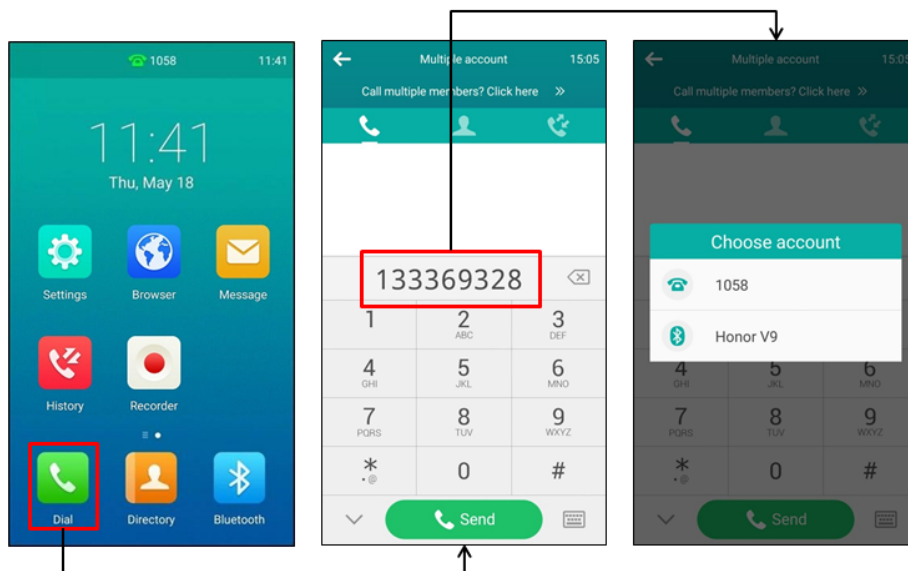

Tap the connected mobile phone in the pop-up dialog box.

To place a mobile call over Bluetooth on your mobile phone:

1. Connect a Bluetooth-Enabled mobile phone with your phone (refer to [Pairing and Connecting the Bluetooth-Enabled Mobile Phone](#)).
2. On your mobile phone, place a call to a desired contact.
The outgoing call information appears on both your IP phone and mobile phone screen.
3. On your mobile phone, select CP960 as your audio source.
 - **Bluetooth:** the audio goes through the IP phone.
 - **Handset earpiece** or **Speaker:** the audio goes through the mobile phone.

The audio goes through the IP phone although the mobile phone screen also shows a connected call. You can hold, mute or end the call on the IP phone, and after you hold the call you can resume the call or place a new call.

Answering Calls

You can answer a call no matter whether you are in another call or not. If you want to answer a new incoming call when in another call, ensure that call waiting has been enabled. For more information on call waiting, refer to [Call Waiting](#) on page 161.

Answering When Not in Another Call

To answer a call:

1. Tap **Answer**.

Answering When in Another Call

To answer a call during a call:

1. Tap  .

The incoming call is answered and the original call is placed on hold.

You can also tap **Join conf** to create a three-way conference with the original call party and incoming call party.

Answer Calls Automatically



You can enable auto answer to automatically answer an incoming call using the speakerphone. You can also enable auto answer mute to mute the local microphone when an incoming call is answered automatically.

To configure auto answer and auto answer mute via phone user interface:

1. Tap **Settings** from the Home screen.
2. Tap **Auto Answer** from the **Features** block.
3. Tap a desired line.
4. Turn on **Auto Answer**.
5. Turn on **Auto Answer Mute**.

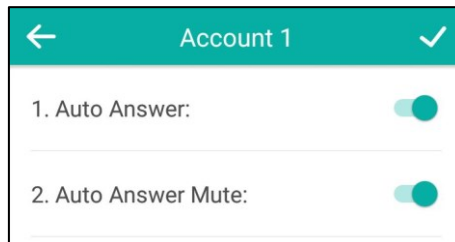
This field appears only if **Auto Answer** is turned on.



6. Tap  to accept the change or  to cancel.
The icon  will display on the status bar.

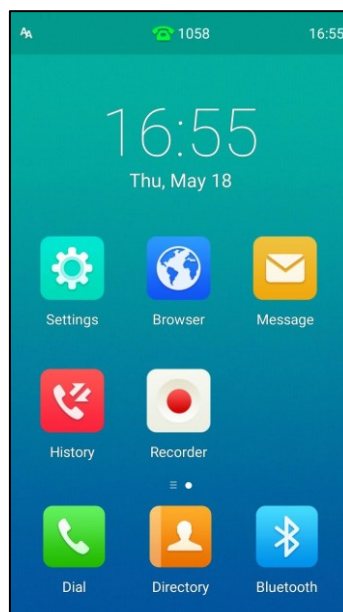

You can also swipe down from the top of the screen to enter the control center and toggle **Auto Answer** on.

Auto answer is configurable via web user interface at the path **Account->Basic**.

Note

Auto answer is only applicable when there is no other call in progress on the phone.

Handling Incoming Calls

When you receive an incoming call, you can do the following:

- Silence an incoming call.
- Rejecting an incoming call.
- Enable Do Not Disturb to reject all calls.
- Set up Call Forwarding to automatically forward all incoming calls.
- Forward an incoming call to a contact.

Silencing an Incoming Call

From the Incoming Call screen, you can stop the phone from playing ring tone.

To silence an incoming call:

1. Tap  .

Rejecting an Incoming Call

You can reject an incoming call. And this call will be logged to Received Calls list.

To reject an incoming call:

1. Tap **Reject**.

Rejecting Calls with Do Not Disturb (DND) Enabled

You can use DND to reject incoming calls automatically on the phone. The prompt message "**n New Missed Call(s)**" ("n" indicates the number of missed calls) will appear on the touch screen, and callers will receive a busy message. All calls you receive while DND is enabled will be logged to Missed Calls list.

Note

The prompt message will display only if Missed Call Log for the line is enabled. Missed call log is configurable via web user interface at the path **Account->Basic->Missed Call Log**.

Do not disturb is local to the phone, and may be overridden by the server settings. For more information, contact your system administrator.

Enabling DND

To enable DND via phone user interface, do one of the following:

- Swipe down from the top of the screen to enter the control center and toggle **DND** on.

- Tap **Settings** from the Home screen.
Tap **DND** from the **Features** block.
Turn on **DND Enable**.
Tap  to accept the change.
- Tap **DND** during a call.

When DND is enabled, the IP phone prompts "DND mode is enabled" and the icon  appears on the status bar.

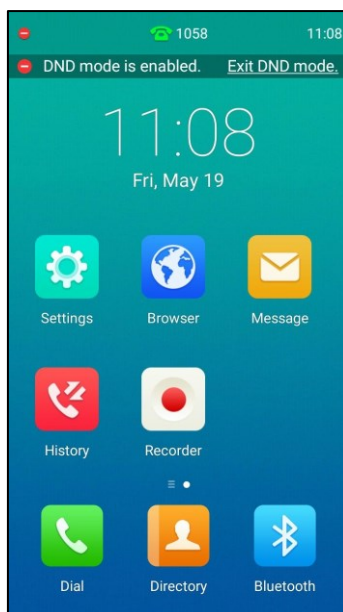

Incoming calls will be rejected automatically and "**n New Missed Call(s)**" ("n" indicates the number of missed calls. e.g., 1 New Missed Call(s)) will appear on the touch screen.

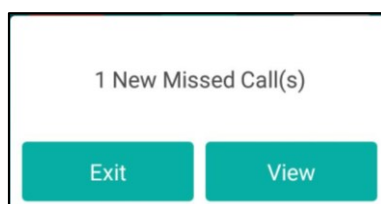

Note

When DND and busy forward are enabled, all incoming calls will be forwarded to the configured destination number. For more information on busy forward, refer to [Forwarding Incoming Calls](#) on page 146.

To configure the DND authorized numbers via web user interface:

1. Click on **Features->Forward & DND**.
2. Select **Enabled** from the pull-down list of **DND Emergency**.

- Enter the numbers in the **DND Authorized Numbers** field.
For multiple numbers, enter a comma between every two numbers.

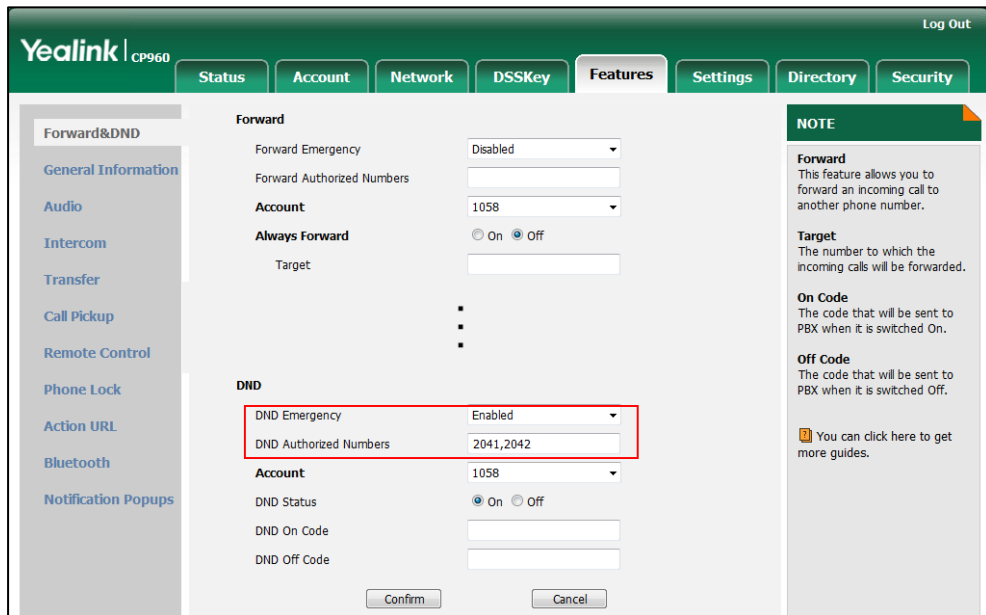

- Click **Confirm** to accept the change.

When DND is enabled on the phone, the phone can still receive incoming calls from the numbers specified in the **DND Authorized Numbers** field.

Note DND authorized number is configurable via web user interface only.
When the phone misses a call, a prompt window will pop up by default. If you want to disable the feature, contact your system administrator for more information.

Disabling DND

To disable DND via phone user interface, do one of the following:

- Tap **Exit DND mode**. from the idle screen.
- Swipe down from the top of the screen to enter the control center and toggle **DND** off.
- Tap **Settings** from the Home screen.
Tap **DND** from the **Features** block.
Turn off **DND Enable**.
Tap  to accept the change.

Forwarding Incoming Calls

You can choose to forward an incoming call to a contact or forward all incoming calls to one of your contacts.

You can forward an incoming call to an international telephone number (refer to [FWD](#))

International). This feature is enabled by default. Incoming calls from some authorized numbers not to be forwarded when the call forward feature is enabled. The incoming call will not be logged in the Forwarded Calls list. This feature is disabled by default.

Note

Call forward is local to the phone, and may be overridden by the server settings. For more information, contact your system administrator.

If DND feature is enabled, the incoming calls will not be forwarded even if you configure no answer forward feature.

When the phone forwards a call, a prompt window will pop up by default. If you want to disable the feature, contact your system administrator for more information.

Forwarding an Incoming Call to a Contact

You can forward an incoming call directly to a contact without answering the call.

To forward an incoming call to a contact:

1. Tap .

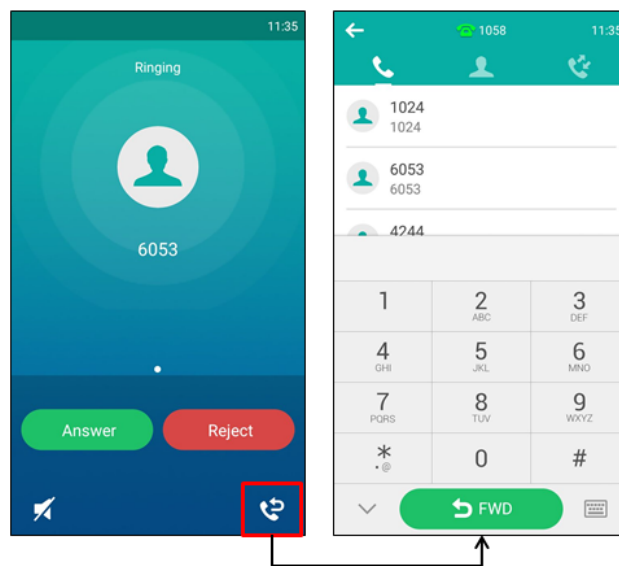

2. Enter the number you want to forward the incoming call to.
3. Tap **FWD**.



The touch screen prompts a call forward message.

Forwarding All Incoming Calls to a Contact

You can set up the IP phone to forward all incoming calls to a contact.

To forward all incoming calls to a contact:

1. Tap **Settings** from the home screen.
2. Tap **Call Forward** from the **Features** block.

3. Tap the desired forwarding type.
 - Always Forward:** Forwards all incoming calls.
 - Busy Forward:** Forwards incoming calls when you're in a call.
 - No Answer Forward:** Forwards all unanswered incoming calls.
 4. Turn on the desired forwarding type.
 5. Enter the number you want to forward to in the **Forward To** field.
 6. If you select **No Answer Forward**, tap the **After Ring Time** field to select a desired ring time to wait before forwarding.
 7. Tap  to accept the change or  to cancel.
- The icon  on the status bar indicates that the call forward is enabled.

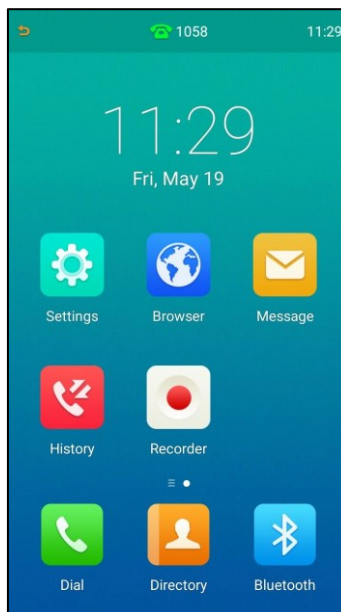

If the forward on code or off code is configured, the IP phone sends the corresponding code to the server when a certain action takes place. For example, if you set the Always Forward on code to be *71 (may vary on different servers), and the target number to be 1234. When you enable Always Forward on the IP phone, the IP phone sends *711234 to the server, and then the server will enable Always Forward feature on the server side, hence being able to get the right status of the extension.

Call forward is configurable via web user interface at the path **Features->Forward & DND**.

Note

You can also enter the SIP URI or IP address in the **Forward To** field. For more information on using the SIP URI or IP address, refer to [Placing Calls](#) on page 139.

To configure the forward authorized numbers via web user interface:

1. Click on **Features->Forward & DND**.
2. Select **Enabled** from the pull-down list of **Forward Emergency**.
3. Enter the numbers in the **Forward Authorized Numbers** field.
For multiple numbers, enter a comma between every two numbers.

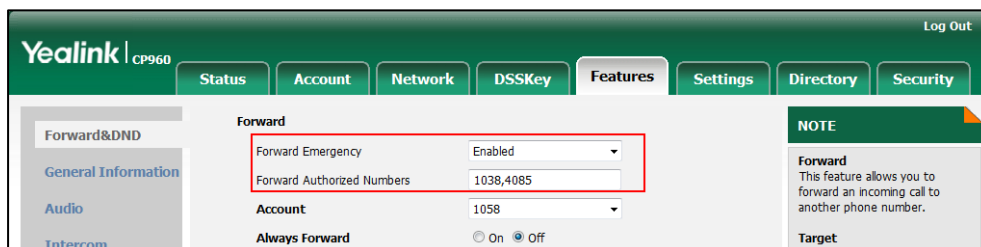

4. Click **Confirm** to accept the change.

When call forward is enabled on the phone, the phone cannot forward incoming calls from the numbers specified in the **Forward Authorized Numbers** field.

Note

Forward authorized number is configurable via web user interface only.

To disable call forwarding:

1. Tap **Settings** from the home screen.
2. Tap **Call Forward** from the **Features** block.
3. Tap the desired forwarding type.
4. Turn off the desired forwarding type.
5. Tap  to accept the change.

Ending Calls

To end a call:

1. Tap **EndCall**.

Speed Dial

You can configure a speed dial key to speed up dialing the numbers frequently used or hard to remember.

To configure a speed dial key:

1. Tap **Settings** from the Home screen.
2. Tap **DSS Keys** from the **Features** block.
3. Tap the desired line key.
4. Tap the **Type** field.

5. Tap **Speed Dial** in the pop-up dialog box.
6. Tap the **Account ID** field.
7. Tap the desired line in the pop-up dialog box.
8. (Optional.) Enter the string that will appear on the touch screen in the **Label** field.
9. Enter the desired number you want to dial out directly in the **Value** field.

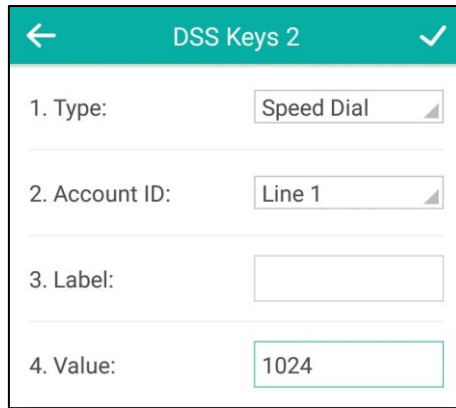

10. Tap ✓ to accept the change or ← to cancel.

Speed dial key is configurable via web user interface at the path **DSSKey->Line key**.

To configure a speed dial key from directory/history:

1. Tap or o .
2. Tap after the desired entry.
3. Tap **Place on dsskey**.

The IP phone will automatically find an available line key and assign the line key for speed dial for the entry.

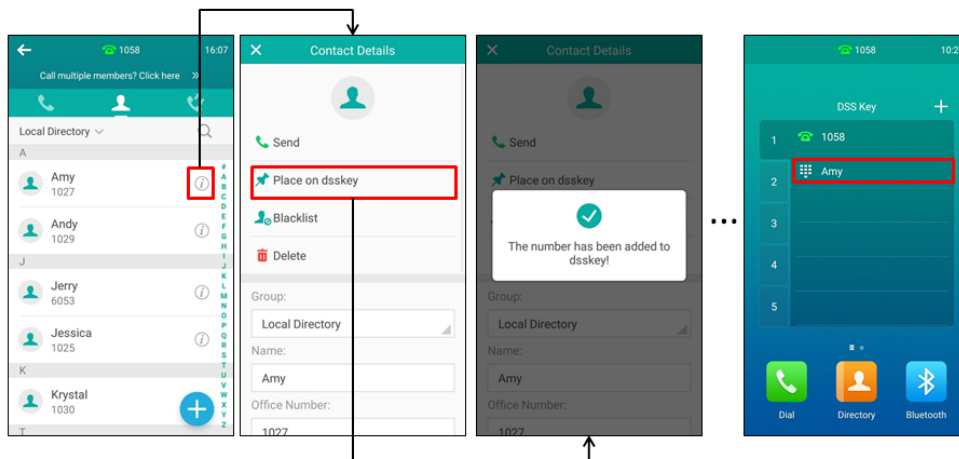

Recent Call In Dialing

To view the placed calls list when the phone is on the dialing interface, you should enable recent call in dialing in advance.

To enable recent call in dialing via web user interface:

1. Click on **Directory**->**Setting**.
2. Select **Enabled** from the pull-down list of **Recent Call In Dialing**.

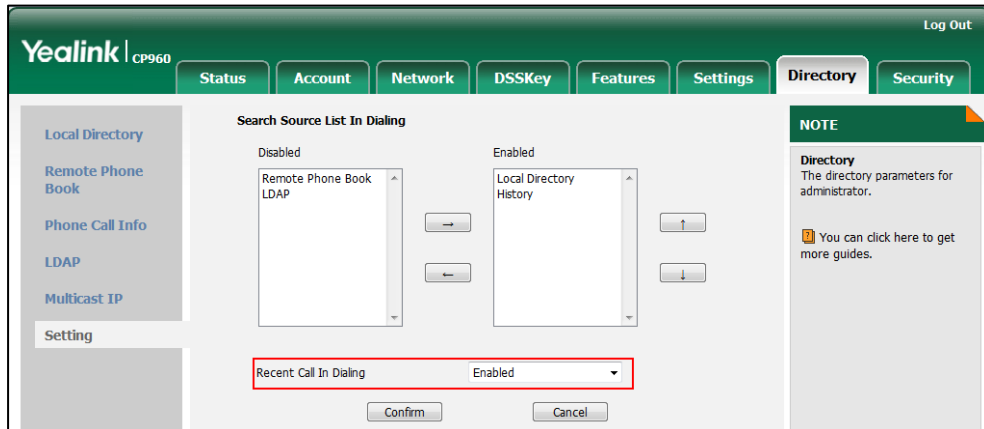

3. Click **Confirm** to accept the change.

Note

Recent call in dialing is configurable via web user interface only.

To view placed calls list when the phone is on the dialing interface:

1. Tap  .
The touch screen displays the placed calls list.
2. Drag up and down to scroll through placed calls.

You can also enter a few continuous characters of the contact name or continuous numbers of the contact number (office, mobile or other number) to search from placed calls list.

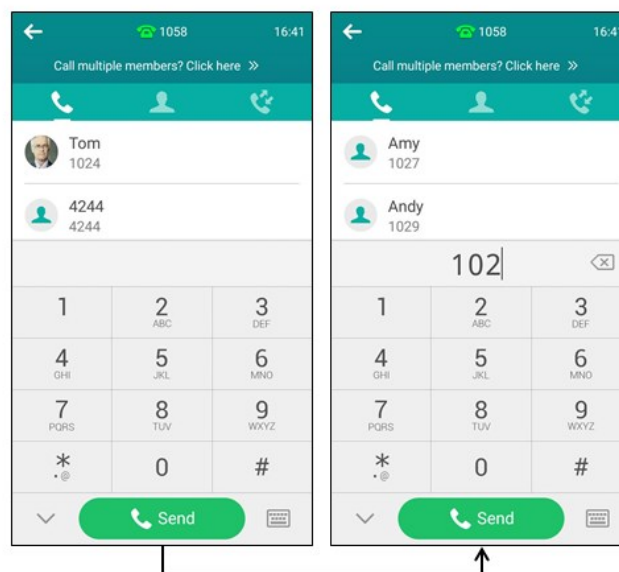



Auto Redial

You can enable auto redial to automatically redial a phone number when the called party is busy. You can also configure the number of auto redial attempts and the time to wait between redial attempts.

To configure auto redial via phone user interface:

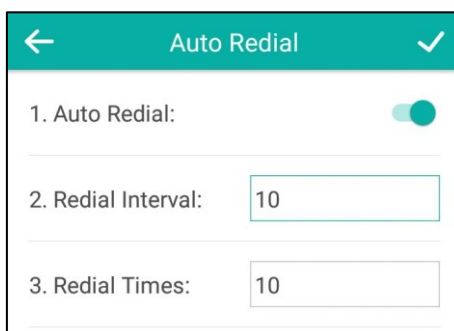
1. Tap **Settings** from the Home screen.
2. Tap **Auto Redial** from the **Features** block.
3. Turn on **Auto Redial**.
4. Enter the desired time (in seconds) in the **Redial Interval** field.
The default value is 10.
5. Enter the desired number of redial attempts in the **Redial Times** field.
The default value is 10.



6. Tap  to accept the change or  to cancel.

Auto redial is configurable via web user interface at the path **Features->General Information**.

To use auto redial:

When the called party is busy, the touch screen prompts “Call Finish” and called party’s avatar displays “Redial”.

1. Tap **OK** to activate auto redial.

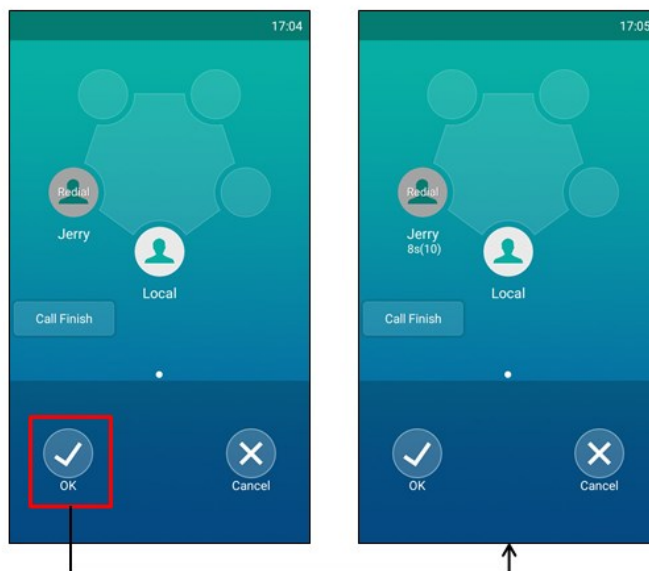

2. Wait for the designated period of time or tap **OK** to redial the phone number. The phone will retry as many times as configured until the called party answers.



Call Completion

You can use call completion to notify the caller who failed to reach a desired party when the party becomes available to receive a call.

To enable call completion via phone user interface:

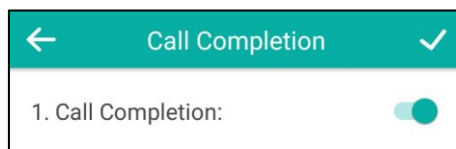
1. Tap **Settings** from the Home screen.
2. Tap **Call Completion** from the **Features** block.
3. Turn on **Call Completion**.



4. Tap  to accept the change or  to cancel.

Call completion is configurable via web user interface at the path **Features->General Information**.

To use call completion:

When the called party is busy, the following prompt will appear on the touch screen of the phone:

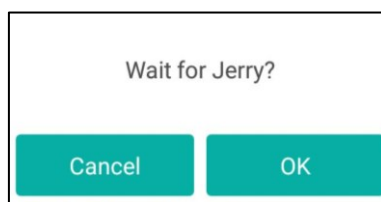

1. Tap **OK**, the phone will then return to the idle screen and call completion will be activated.

When the called party becomes idle, the following prompt will appear on the touch screen of the phone:

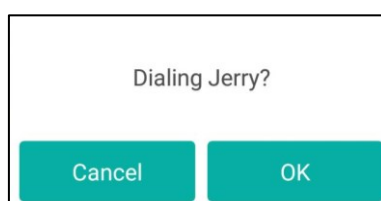

1. Tap **OK** to redial the number.

Note

Call completion is not available on all servers. For more information, contact your system administrator.

Recall

You can use the recall key to place a call back to the last incoming call.

To configure a recall key via phone user interface:

1. Tap **Settings** from the Home screen.
2. Tap **DSS Keys** from the **Features** block.
3. Tap the desired line key.
4. Tap the **Type** field.
5. Tap **Key Event** in the pop-up dialog box.
6. Tap the **Key Type** field.
7. Tap **ReCall** in the pop-up dialog box.

- (Optional.) Enter the string that will appear on the touch screen in the **Label** field.

- Tap to accept the change or to cancel.

Recall key is configurable via web user interface at the path **DSSKey->Line key**.

To place a call back to the last incoming call using a recall key:

- Tap the recall key from the DSS key screen.

Call Mute/Unmute

The following occurs when you mute the microphone:

- The other party cannot hear you but you can still hear all other parties.
- You cannot record your voice (refer to [Call and Conference Recording \(Local\)](#)).

You can mute the microphone in any status.

The mute state persists across calls, and the phone stays in the mute state until you unmute the microphone or until the phone restarts.

Note

Contact your system administrator, if you can only mute the microphone during an active call or the mute feature is deactivated when the active call ends.

To mute the microphone, do one of the following:

- Tap the Mute touch key in any status.

- Swipe down from the top of the screen to enter the control center and toggle **Mute** on.
Note that you cannot enter the control center when calling, ringing or in a call.

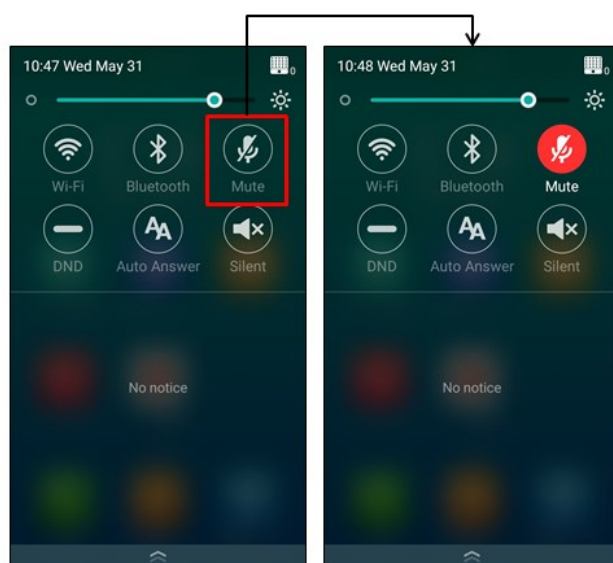

- When in a call, tap **Mute**.

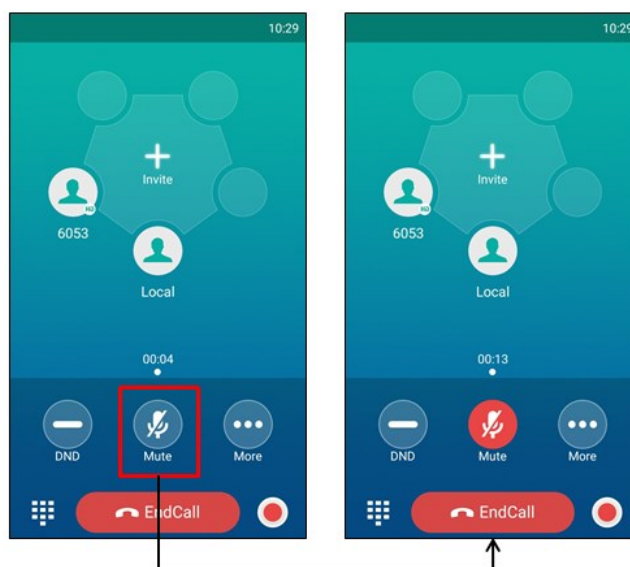

The mute key LED illuminates solid red and the icon  appears on the status bar.

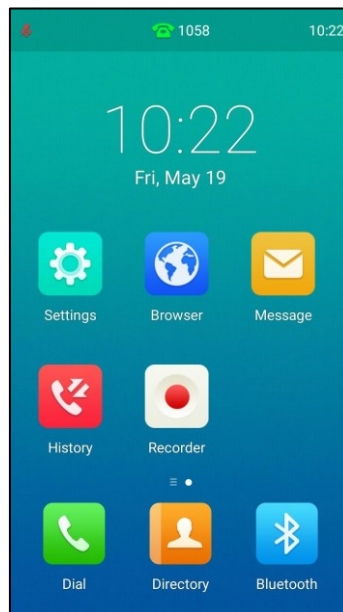

To unmute the microphone:

- Tap the Mute touch key again.
- Swipe down from the top of the screen to enter the control center and toggle **Mute** off.
- Tap **Mute** again.

Call Hold/Resume

You can place an active call on hold. Only one active call can be in progress on the phone at any time. Other calls can be made and received while placing the original call on hold. When you place a call on hold, your IP PBX may play music to the other party while waiting.

To place a call on hold:

1. Tap **More**->**Hold** during a call.

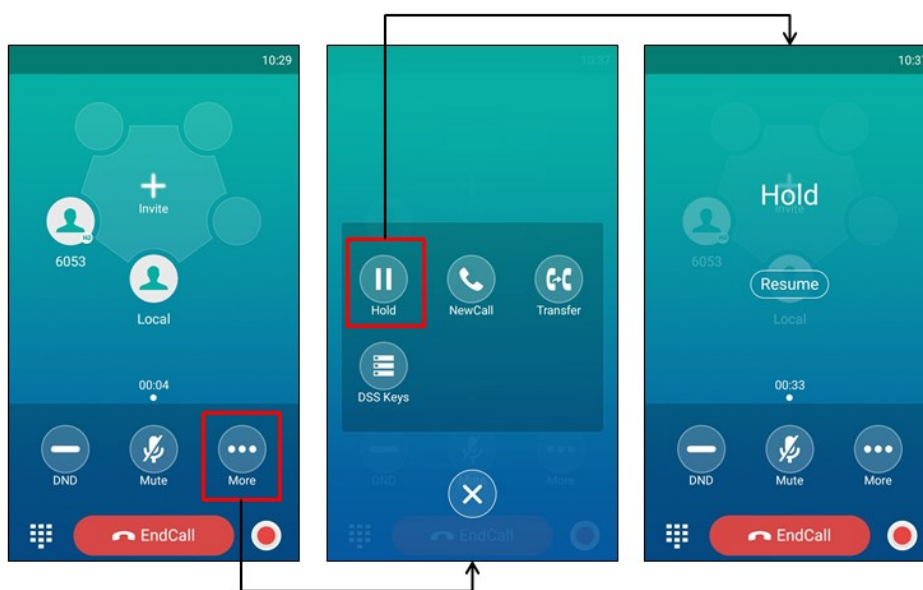

The phone will beep softly every 30 seconds to remind you that you still have a call on hold.

To resume a held call, do one of the following:

- Tap **Resume**.
- Tap **More**->**Resume**.

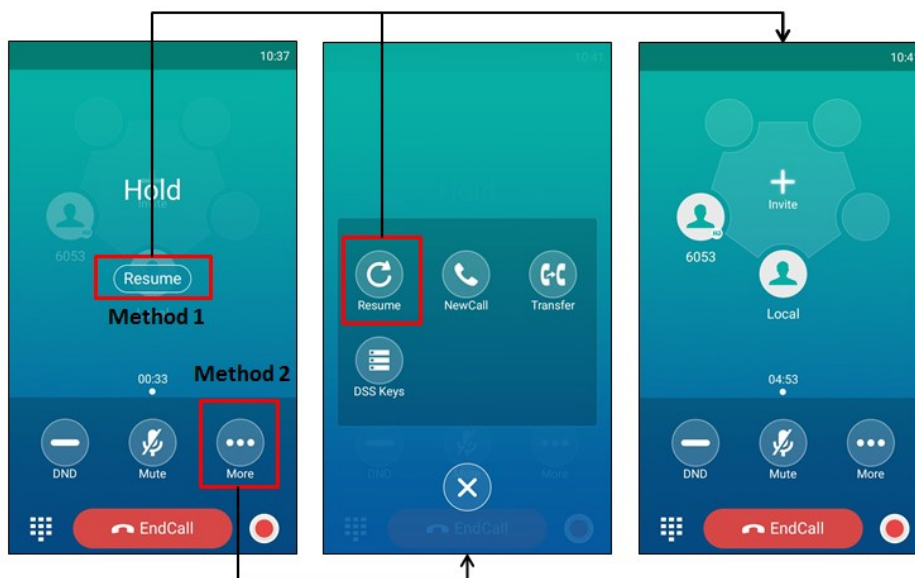

Multiple Calls on Hold:

If multiple calls are placed on hold, do one of the following:

- Tap **Previous call/Next call** or swipe left/right to switch to desired call screen, tap **Resume**
- Tap **Previous call/Next call** or swipe left/right to switch to desired call screen, tap **More->Resume**.

Call Transfer

You can transfer a call to another party in one of three ways:

- **Blind Transfer:** Transfer a call directly to another party without consulting.
- **Semi-Attended Transfer:** Transfer a call when the target phone is ringing.
- **Attended Transfer:** Transfer a call with prior consulting.



Blind Transfer

Before performing a blind transfer (except you use dial number method), make sure that the transfer mode via Dsskey is configured as **Blind Transfer**. For more information on how to configure it, refer to [Configuring Transfer Mode via DssKey](#) on page 182.

To perform a blind transfer:

1. Tap **More->Transfer** during a call.
2. Do one of the following:
 - Enter the number you want to transfer the call to.
Tap **Transfer**.
 - Tap **Transfer** to complete the transfer. (The call will automatically dial out in about 5 seconds if you do not tap **Transfer**.)



- Tap  Search for the contact and tap the desired contact to complete the transfer.
- Tap  and then tap -> **Remote Phone Book**. Search for the contact and tap the desired contact to complete the transfer. (Remote phone book should be configured in advance, refer to [Remote Phone Book](#) on page 97 for more information.)
- Tap  and then select the desired list. Tap the desired entry to complete the transfer.

The call is then connected to the number to which you are transferring.



Semi-Attended Transfer

Before performing a semi-attended transfer (except you use dial number method), make sure that the transfer mode via Dsskey is configured as **New Call** or **Attended Transfer**. For more information on how to configure it, refer to [Configuring Transfer Mode via DssKey](#) on page 182.

To perform a semi-attended transfer:

1. Tap **More**->**Transfer** during a call.
2. Do one of the following:
 - Enter the number you want to transfer the call to.
Tap **Transfer**.
Tap **Send** to dial out. (The call will automatically dial out in about 5 seconds if you do not tap **Send**.)





- Tap  Search for the contact and tap the desired contact and tap the desired contact to dial out.
- Tap  and then tap -> **Remote Phone Book**. Search for the contact and tap the desired contact to dial out. (Remote phone book should be configured in advance, refer to [Remote Phone Book](#) on page 97 for more information.)

- Tap  and then select the desired list. Tap the desired entry to dial out.
3. Tap **Transfer** to complete the transfer when receiving ringback.

Attended Transfer

Before performing an attended transfer (except you use dial number method), make sure that the transfer mode via Dsskey is configured as **New Call** or **Attended Transfer**. For more information on how to configure it, refer to [Configuring Transfer Mode via DssKey](#) on page 182.

To perform an attended transfer:

1. Tap **More**->**Transfer** during a call.
2. Do one of the following:
 - Enter the number you want to transfer the call to.
Tap **Transfer**. The phone will prompt a dialog box. Tap **Send** to dial out. (The call will automatically dial out in about 5 seconds if you do not tap **Send**.)
 - Tap  Search for the contact and tap the desired contact and tap the desired contact to dial out.
 - Tap  and then tap -> **Remote Phone Book**. Search for the contact and tap the desired contact to dial out. (Remote phone book should be configured in advance, refer to [Remote Phone Book](#) on page 97 for more information.)
 - Tap  and then select the desired list. Tap the desired entry to dial out.
3. After the party answers the call, tap **Transfer** to complete the transfer.

Call Waiting

You can enable or disable call waiting on the phone. If call waiting is enabled, you can receive another call when there is already an active call on the phone. Otherwise, another incoming call is automatically rejected by the phone with a busy message when there is an active call on the phone. You can also enable or disable the phone to play a warning tone when receiving another call.



To configure call waiting via phone user interface:

1. Tap **Settings** from the Home screen.
2. Tap **Call Waiting** from the **Features** block.
3. Turn on **Call Waiting**.
4. Turn on **Play Tone**.

5. (Optional.) Enter the call waiting on code or off code respectively in the **On Code** or **Off Code** field.

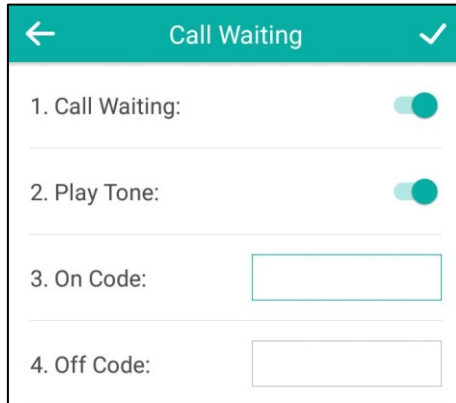
If on code or off code is configured, the IP phone will send the corresponding code to activate or deactivate call waiting on the server. They may vary on different servers.



6. Tap  to accept the change or  to cancel.

Call waiting is configurable via web user interface at the path **Features->General Information**.

Conference

You can use the CP960 IP phone to create a conference using the phone's local conference and network conference. During a conference, you can manage each participant.

Note Network conference is not available on all servers. For more information, contact your system administrator.

Local Conference

The CP960 IP phone supports up to five parties (including yourself) in a conference call.

There are three ways to create a conference:

- Initiating a conference by dialing multiple numbers.
- Initiating a conference by inviting participants.
- Merging multiple calls into a conference.

If you connect a mobile phone and PC to your IP phone, you can also create a hybrid UC conference.

The following figure shows what the touch screen looks like in a five-way conference call:

The avatar of the talking party shows water ripples

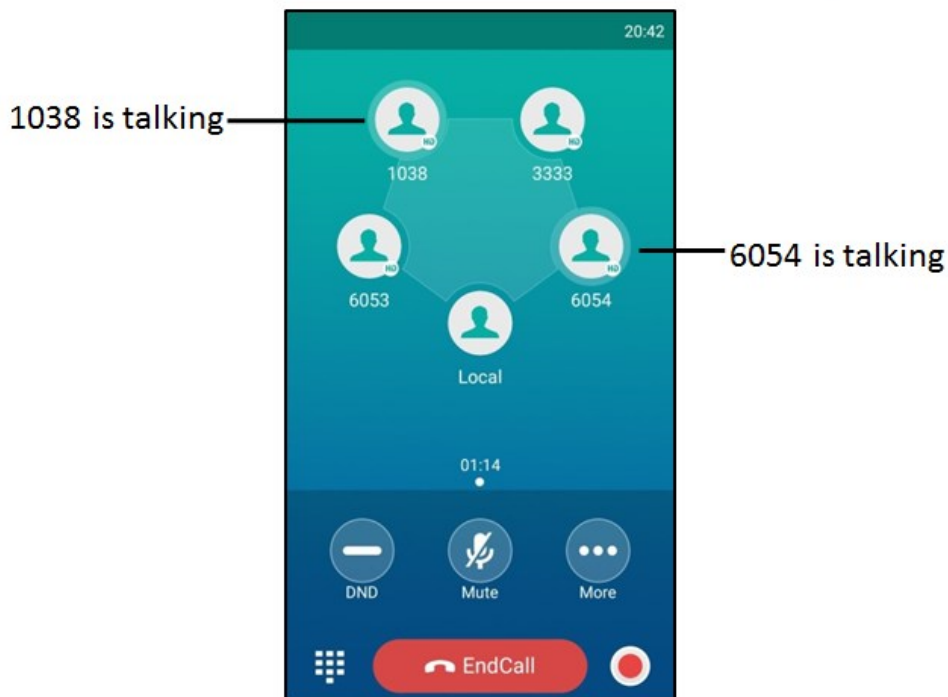



Initiating a Conference by Dialing Multiple Numbers

To initiate a conference by dialing multiple contacts:

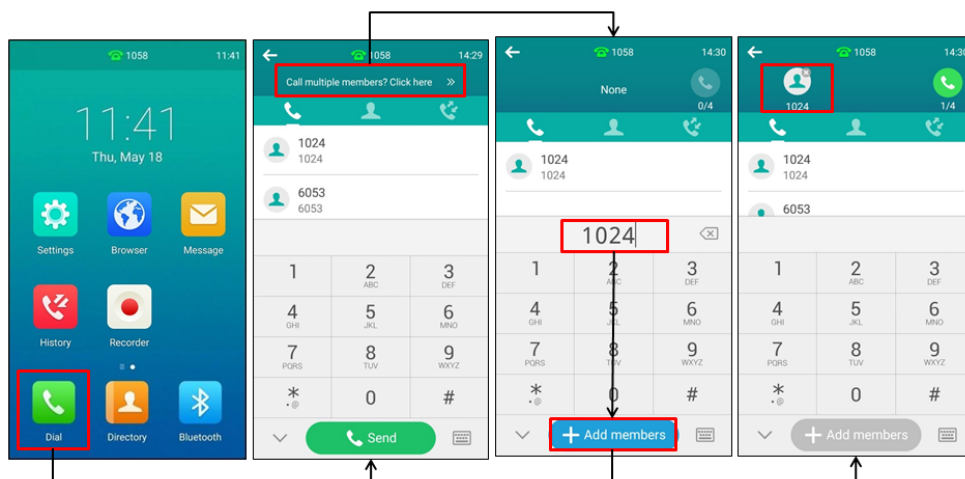

1. Tap .
2. Tap **Call multiple members? Click here >>**.
3. Enter the number of the first party then tap **Add members** or select a contact from **Directory** or **History**.

The avatar of the first party appears on the top of touch screen. You can tap the avatar to cancel the addition.



4. Repeat the step 3 until you add all intended parties.
5. Tap  to call all intended parties at the same time.

Note

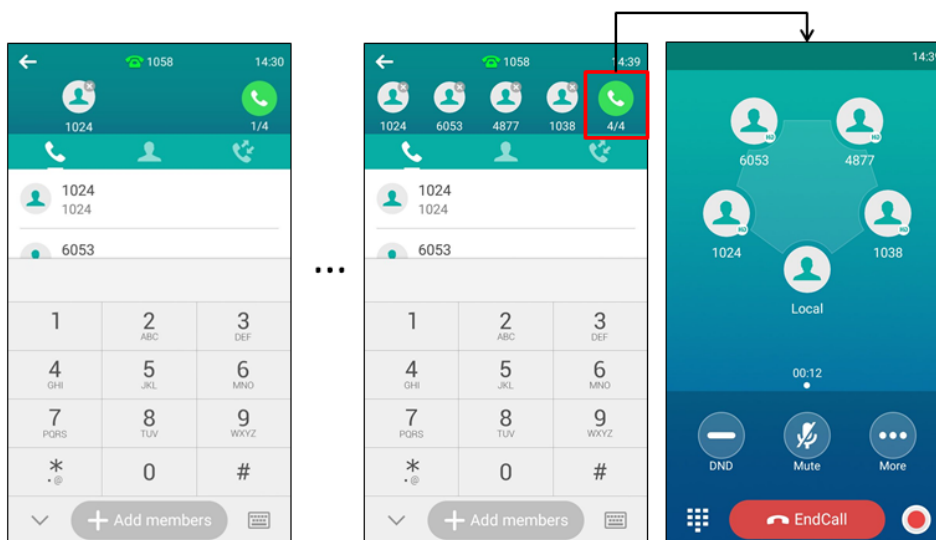

The value under the icon  indicates the number of parties you have added and the maximum number of the parties you can add. For example,  indicates you can add up to 4 parties and you have added 1 party.

The conference is set up after the intended parties answer the call.



Initiating a Conference by Inviting Participants

To initiate a conference by inviting participants:

1. Place a call to the first party.
2. When the first party answers the call, tap **Invite**.
3. Do one of the following:
 - Enter the number of the second party, and then tap **Invite**.
 - Tap , tap a desired contact to dial out.
 - Tap , tap the desired history record to dial out.

Repeat the step above until you add all intended parties.



– Tap **Call multiple members? Click here >>**.

Enter the number of the first party then tap **Add members** or select a contact from **Directory** or **History**.

Repeat the step above until you add all intended parties.

Tap  to call all intended parties at the same time.

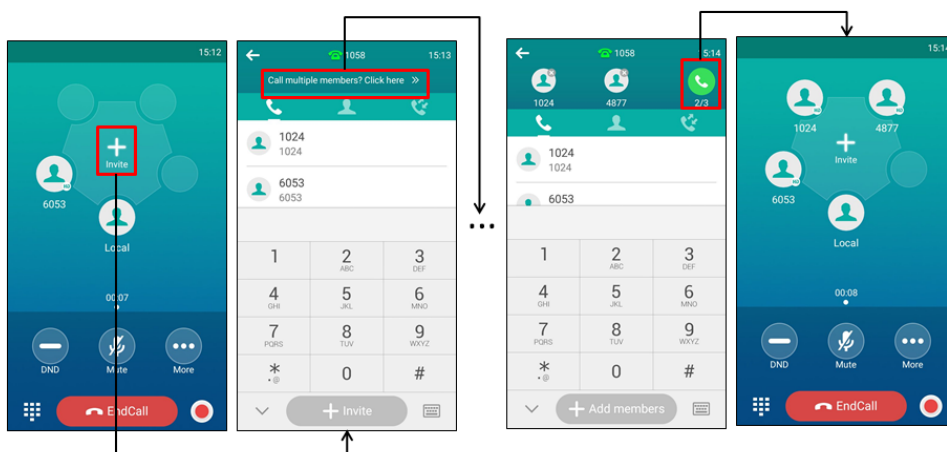

Merging Multiple Calls into a Conference Call

To merge multiple calls into a conference call:

1. Tap **Merge calls**.

The calls are merged into a conference call.

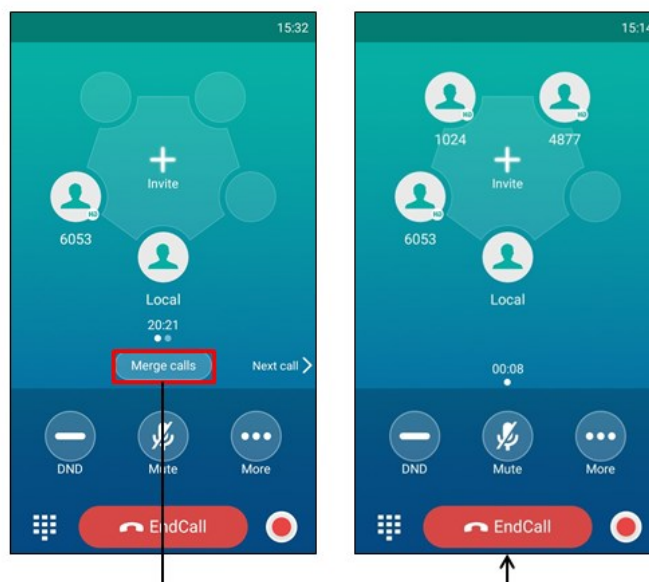

Creating a Hybrid UC Conference

You can merge the calls on your IP phone, the PC and connected mobile phone into a hybrid UC conference. There are many ways to create a hybrid UC conference, the following shows an example.

To create a hybrid UC conference:

1. Make sure you have connected a mobile phone to your IP phone (refer to [Pairing and Connecting the Bluetooth-Enabled Mobile Phone](#)).
2. Make sure you have an active PC audio (refer to [Connecting the PC Audio](#)).
3. Tap **Invite**.
4. Do the following to place a mobile call over Bluetooth on the IP phone.
Enter the desired number.
Tap **Invite**.
Tap the connected mobile phone in the pop-up dialog box.
5. Tap **Invite**.
6. Do the following to place an IP call.
Enter the desired number.
Tap **Invite**.
Tap the registered account.

The hybrid UC conference is created.

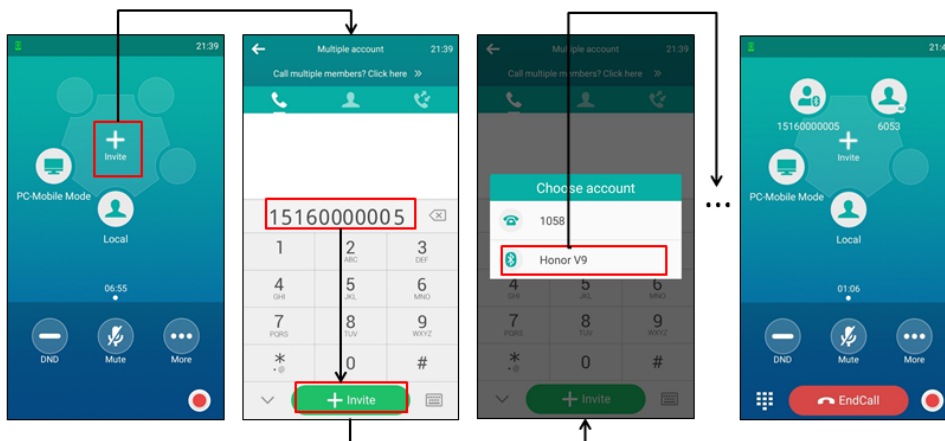

Managing the Conference

During the conference call, you can do the following:

- Tap **More**->**Hold** to place the conference call on hold.
- Tap **More**->**NewCall** to place a new call.
- Tap **More**->**Split** to split the conference call into individual calls on hold.
- Tap **DND** to enable or disable the DND mode.
- Tap **Mute** to mute the conference call, all other participants can hear each other, but they cannot hear you.
- Tap **EndCall** to drop the conference call.
- Tap the avatar of desired participant, the touch screen displays as following:

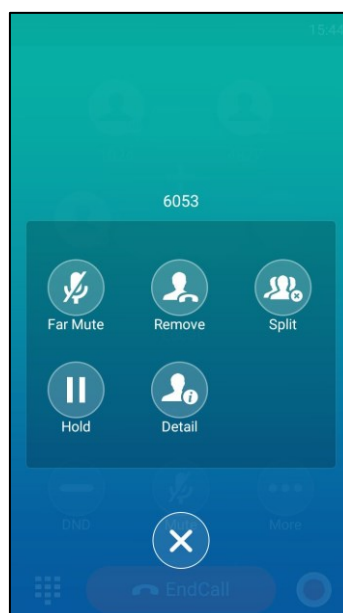

You can do the following:

- Tap **Far Mute** to mute the participant. The muted participant can hear everyone, but no one can hear the muted participant.
- Tap **Remove** to remove the participant from the conference.
- Tap **Split** to split the participant from the conference.
- Tap **Hold/Resume** to hold/resume the participant.
- Tap **Detail** to view the participant information.
- Tap  to return to the conference screen.

Network Conference

You can use network conference feature on the CP960 IP phone to conduct an conference with multiple participants.

This feature allows you to perform the following:

- Join calls together in a conference call.
- Invite other party into an active conference call.

To use this feature, contact your system administrator for the network conference URI in advance.

Note

Network conference is not available on all servers. Contact your system administrator for more information.

To configure network conference via web user interface:

1. Click on **Account->Advanced**.
2. Select the desired account from the pull-down list of **Account**.
3. Select **Network Conference** from the pull-down list of **Conference Type**.

- Enter the conference URI (e.g., conference@example.com) in the **Conference URI** field.

The screenshot shows the Yealink CP960 web interface. The 'Account' tab is selected, and the 'Account 1' configuration page is displayed. The 'Conference Type' dropdown menu is set to 'Network Conference', and the 'Conference URI' text field contains 'conference@example.com'. A red rectangular box highlights these two fields. Other configuration options include 'Keep Alive Type' (Default), 'Keep Alive Interval(Seconds)' (30), 'RPort' (Disabled), 'Subscribe Period(Seconds)' (1800), 'DTMF Type' (RFC2833), 'Early Media' (Disabled), 'SIP Server Type' (Default), 'Music Server URI', 'Out Dialog BLF' (Disabled), and 'VQ RTPC-XR Collector' settings (name, address, port 5060). A 'Confirm' button is visible at the bottom of the form. On the right, a 'NOTE' section indicates that advanced parameters are for administrators and provides a link to more guides.

- Click **Confirm** to accept the change.

Note Network conference is configurable via web user interface only.

To set up a network conference call:

- Place a call to the first party.
- When the first party answers the call, tap **Invite**.
- Do one of the following:
 - Enter the number of the second party, and then tap **Invite**.
Repeat the step above until you add all intended parties.
 - Tap **Call multiple members? Click here >>**.
Enter the number of the new party, and then tap **Add members**.
Repeat the step above until you add all intended parties.
 - Tap  to call all intended parties at the same time.

The procedures to set up a network conference call on specific servers may be different from introduced above. Contact your system administrator for more information.

Call Park

You can use call park to place a call on hold, and then retrieve the call from another phone in the system (for example, a phone in another office or conference room). You can park an active call by tapping the call park key on the phone. If the call is parked successfully, the response is

either a voice prompt confirming that the call was parked, or a visible prompt on the touch screen.

Note

Call park is not available on all servers. Contact your system administrator for more information.

To configure a call park key via phone user interface:

1. Tap **Settings** from the Home screen.
2. Tap **DSS Keys** from the **Features** block.
3. Tap the desired line key.
4. Tap the **Type** field.
5. Tap **Key Event** in the pop-up dialog box.
6. Tap the **Key Type** field.
7. Tap **Call Park** in the pop-up dialog box.
8. Tap the **Account ID** field.
9. Tap the desired line in the pop-up dialog box.
10. (Optional.) Enter the string that will appear on the touch screen in the **Label** field.
11. Enter the call park code in the **Value** field.

The screenshot shows a configuration dialog titled "DSS Keys 3". It contains five rows of settings:

- 1. Type: Key Event
- 2. Key Type: Call Park
- 3. Account ID: Line 1
- 4. Label: (empty text box)
- 5. Value: *04

12. Tap ✓ to accept the change or ← to cancel.

Call park key is configurable via web user interface at the path **DSSKey->Line Key**.

To use call park:

1. User on phone A places a call to phone B.
2. User on phone A wants to take the call in a conference room for privacy, and so taps the call park key on phone A.
3. User on phone A walks to an available conference room where the phone is designated as phone C. The user dials the call park retrieve code to retrieve the parked call.

The system establishes the call between phone C and B.

Note

The call park code and call park retrieve code are predefined on the system server. Contact your system administrator for more information.

If the parked call is not retrieved within a period of time assigned by the system, the phone performing call park will receive a call back.

Call Pickup

You can use call pickup to answer someone else's incoming call on your phone. The CP960 IP phone supports directed call pickup and group call pickup. Directed call pickup is used for picking up a call that is ringing at a target phone number. Group call pickup is used for picking up a call that is ringing at any phone number in a certain group. The pickup group should be predefined, contact your system administrator for more information.

You can pick up an incoming call by tapping **DPickup/GPickup** on the dialing screen. To use call pickup, you need to configure the call pickup code beforehand on a global or per-line basis via web user interface. The call pickup code configured on a per-line basis takes precedence over that configured on a global basis.

Note

If there are many incoming calls at the same time, tapping **GPickup** on the phone will pick up the call that rings first.

Directed Call Pickup

To enable directed call pickup and configure the directed call pickup code on a global basis via web user interface:

1. Click on **Features->Call Pickup**.
2. Select **Enabled** from the pull-down list of **Directed Call Pickup**.
3. Enter the directed call pickup code in the **Directed Call Pickup Code** field.

The screenshot shows the 'Call Pickup' configuration page in the Yealink CP960 web interface. The 'Features' tab is selected. The 'Call Pickup' section has the following settings:

Feature	Value
Directed Call Pickup	Enabled
Directed Call Pickup Code	*97
Group Call Pickup	Disabled
Group Call Pickup Code	
Visual Alert for BLF Pickup	Enabled
Audio Alert for BLF Pickup	Enabled

Buttons for 'Confirm' and 'Cancel' are visible at the bottom. A 'NOTE' box on the right states: 'Call Pickup: The call pickup parameters for administrator. You can click here to get more guides.'

4. Click **Confirm** to accept the change.

To configure the directed call pickup code on a per-line basis via web user interface:

1. Click on **Account->Advanced**.
2. Select the desired account from the pull-down list of **Account**.
3. Enter the directed call pickup code in the **Directed Call Pickup Code** field.

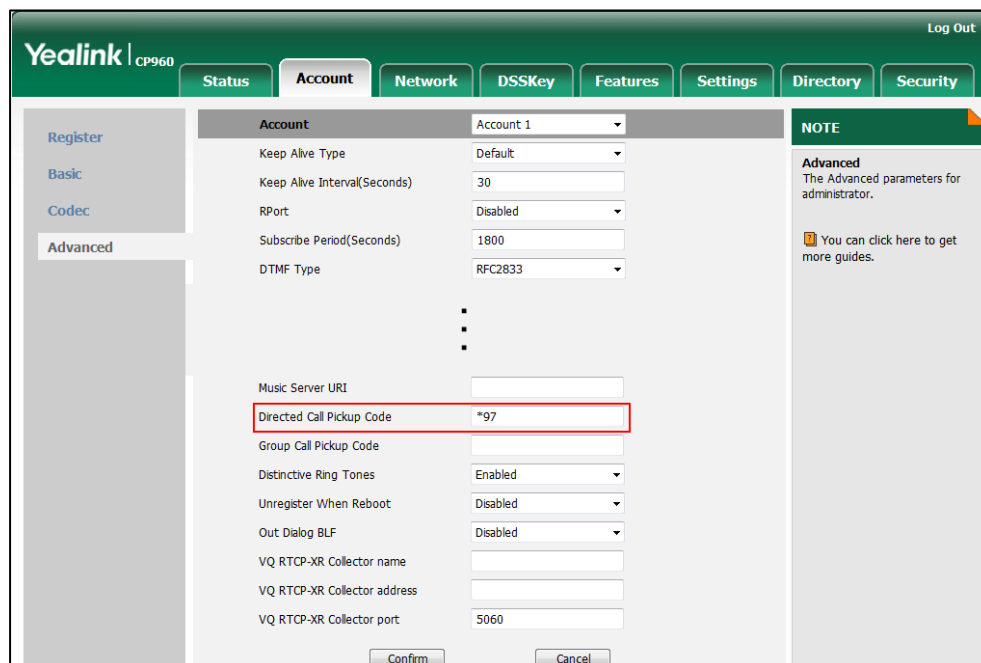

4. Click **Confirm** to accept the change.

To pick up a call directly:

1. Tap  .
DPickup appears on the touch screen.

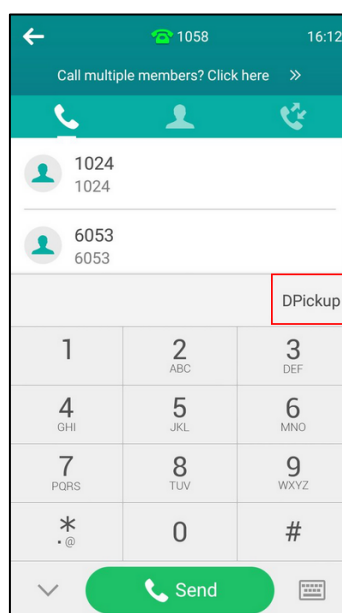

2. Tap **DPickup** on your phone when the target phone receives an incoming call.

3. Enter the phone number which is receiving an incoming call.
4. Tap **DPickup** again.

The call is answered on your phone.

You can also configure a line key as a direct pickup key via phone user interface or web user interface. Once configured, you can pick up a call by tapping the direct pickup key directly. For more information, refer to [Line Keys](#) on page 104.

Group Call Pickup

To enable group call pickup and configure the group call pickup code on a global basis via web user interface:

1. Click on **Features->Call Pickup**.
2. Select **Enabled** from the pull-down list of **Group Call Pickup**.
3. Enter the group call pickup code in the **Group Call Pickup Code** field.

The screenshot shows the Yealink CP960 web user interface. The top navigation bar includes 'Status', 'Account', 'Network', 'DSSKey', 'Features', 'Settings', 'Directory', and 'Security'. The 'Features' tab is selected, and the 'Call Pickup' configuration page is displayed. The 'Group Call Pickup' option is set to 'Enabled' and the 'Group Call Pickup Code' is set to '*98'. A red box highlights these two fields. The page also includes a 'NOTE' section on the right and 'Confirm' and 'Cancel' buttons at the bottom.

4. Click **Confirm** to accept the change.

To configure the group call pickup code on a per-line basis via web user interface:

1. Click on **Account->Advanced**.
2. Select the desired account from the pull-down list of **Account**.

- Enter the group call pickup code in the **Group Call Pickup Code** field.

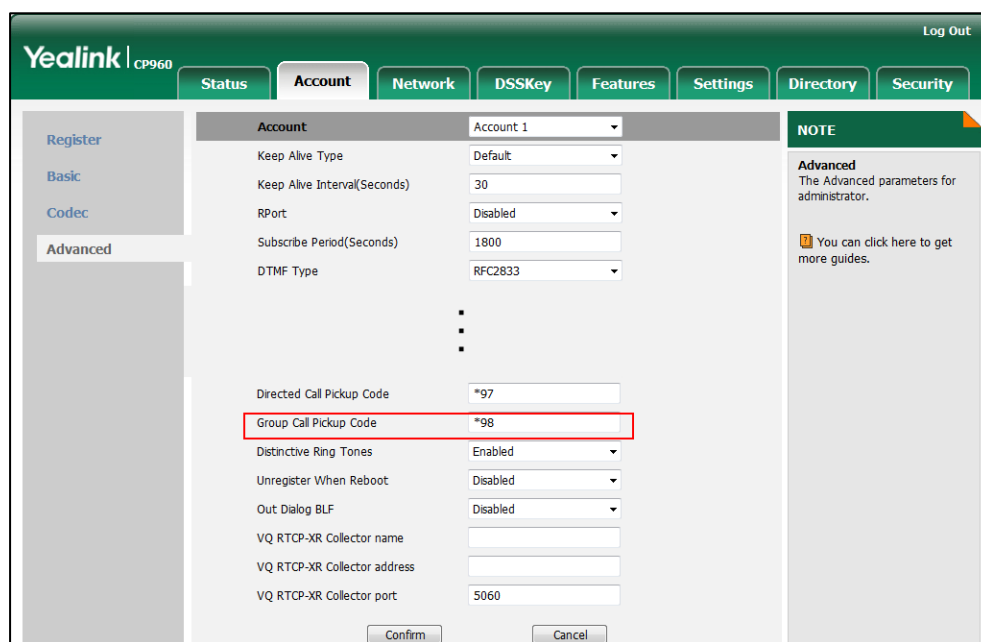

- Click **Confirm** to accept the change.

To pick up a call in the group:

- Tap  .

GPickup appears on the touch screen.

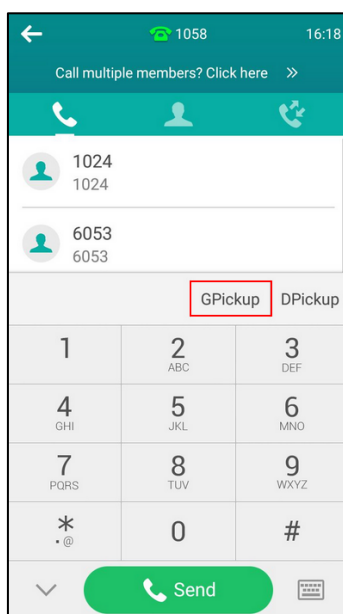

- Tap **GPickup** on your phone when a phone in the group receives an incoming call. The call is answered on your phone.

You can also configure a line key as a group pickup key via phone user interface or web user interface. Once configured, you can pick up a call by tapping the group pickup key directly.

Note

The directed call pickup code and group call pickup code are predefined on the system server. Contact your system administrator for more information.

Anonymous Call

You can use anonymous call to block your identity and phone number from appearing to the called party when you call someone. For example, you want to call to consult some of the services, but don't want to be harassed. Anonymous call is configurable on a per-line basis. You can also configure the phone to send anonymous call on/off code to the server to activate/deactivate anonymous call on the server side.

Note

Anonymous call is not available on all servers. Contact your system administrator for the anonymous call on code and off code.

To configure anonymous call via phone user interface:

1. Tap **Settings** from the Home screen.
2. Tap **Anonymous** from the **Features** block.
3. Tap the desired line.
4. Turn on **Local Anonymous**.
5. (Optional.) Turn on **Send Anony Code**.
6. (Optional.) Enter the anonymous call on code and off code respectively in the **On Code** and **Off Code** field beneath the **Send Anony Code** field.

The phone will send the configured on code or off code depending on your selection when you enable or disable anonymous call feature on the phone.

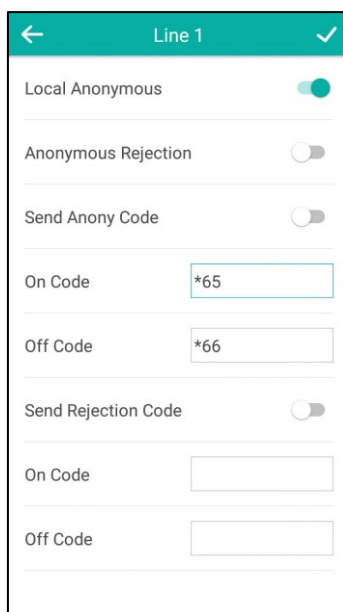

7. Tap to accept the change or to cancel.

Anonymous call is configurable via web user interface at the path **Account->Basic**.

To place an anonymous call:

1. Using the specific line on the phone to place a call to phone B.
The touch screen of phone B prompts an incoming call from anonymous.

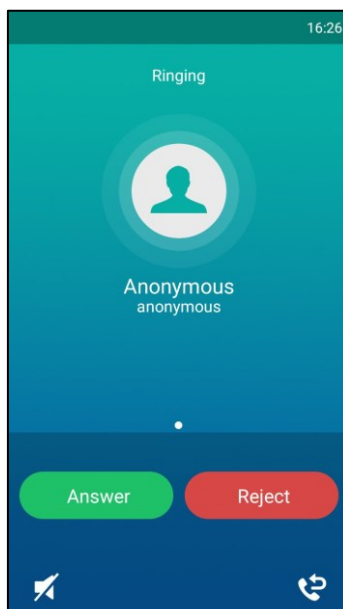

Anonymous Call Rejection

You can use anonymous call rejection to reject incoming calls from anonymous callers.



Anonymous call rejection automatically rejects incoming calls from callers who deliberately block their identities and numbers from being displayed. Anonymous call rejection is configurable on a per-line basis. You can also configure the phone to send anonymous call rejection on/off code to the server to activate/deactivate anonymous call rejection on the server side.

To configure anonymous call rejection via phone user interface:

1. Tap **Settings** from the Home screen.
2. Tap **Anonymous** from the **Features** block.
3. Tap the desired line.
4. Turn on **Anonymous Rejection**.
5. (Optional.) Turn on **Send Rejection Code**.
6. (Optional.) Enter the anonymous call rejection on code and off code respectively in the **On Code** and **Off Code** field beneath the **Send Rejection Code** field.

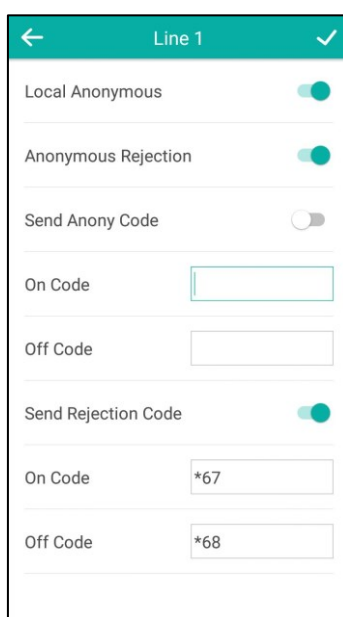
The phone will send the configured on code or off code depending on your selection when you enable or disable anonymous call rejection feature on the phone.



7. Tap  to accept the change or  to cancel.

Anonymous call rejection is configurable via web user interface at the path **Account**->**Basic**.

If phone B has anonymous call feature enabled and places a call to your phone, the call will be rejected, and the touch screen of the phone B will display the following:

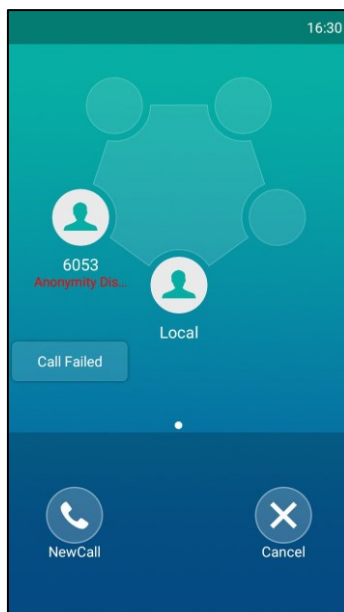

Advanced Phone Features

This chapter provides operating instructions for the advanced features of the CP960 IP phone.

Topics include:

- [Busy Lamp Field \(BLF\)](#)
- [BLF List](#)
- [Call Recording](#)
- [Hot Desking](#)
- [Intercom](#)
- [Multicast Paging](#)
- [Music on Hold](#)
- [Shared Call Appearance \(SCA\)](#)
- [Message](#)

If you require additional information or assistance with your new phone, contact your system administrator.

Busy Lamp Field (BLF)

You can use BLF to monitor a specific line for status changes on the phone. For example, you can configure a BLF key on the phone to monitor the status of a friend's line (busy or idle). The BLF key icon illuminates solid red when the friend's line is in use. For more BLF key icon, refer to [Icon indicator \(associated with BLF/BLF List\)](#) on page 17.

Configuring the BLF Feature on the Phone

You need to configure the IP phone to perform BLF monitoring. IP phones being monitored do not require any configuration.

Configuring a BLF Key

To configure a BLF key via phone user interface:

1. Tap **Settings** from the Home screen.
2. Tap **DSS Keys** from the **Features** block.
3. Tap the desired line key.
4. Tap the **Type** field.
5. Tap **BLF** in the pop-up dialog box.
6. Tap the **Account ID** field.

7. Tap the desired line in the pop-up dialog box.
8. (Optional.) Enter the string that will appear on the touch screen in the **Label** field.
9. Enter the phone number or extension you want to monitor in the **Value** field.
10. (Optional.) Enter the directed call pickup code in the **Extension** field.

If it is configured, when the monitored user receives an incoming call, the supervisor can tap the BLF key to pick up the call directly.

11. Tap ✓ to accept the change or ← to cancel.

BLF key is configurable via web user interface at the path **DSSKey->Line key**.

Configuring Visual and Audio Alert for BLF pickup

You can enable audio alert feature for BLF pickup on the phone. This allows the monitoring phone to play a warning tone when the monitored line receives an incoming call. You can also enable visual alert feature for BLF pickup on the phone. This allows the touch screen of the monitoring phone to display the caller ID when the monitored line receives an incoming call.

To enable visual and audio alert features via web user interface:

1. Click on **Features->Call Pickup**.
2. Select **Enabled** from the pull-down list of **Visual Alert for BLF Pickup**.
3. Select **Enabled** from the pull-down list of **Audio Alert for BLF Pickup**.

4. Click **Confirm** to accept the change.

Note

Visual and audio alert features are configurable via web user interface only.

When the monitored line receives an incoming call, the following occurs on your phone:

- The phone plays a warning tone (if enabled).
- The BLF key icon flashes red.
- The caller ID appears on the touch screen (if enabled).

In the following figure, the touch screen shows an incoming call from 6053 on the monitored line.

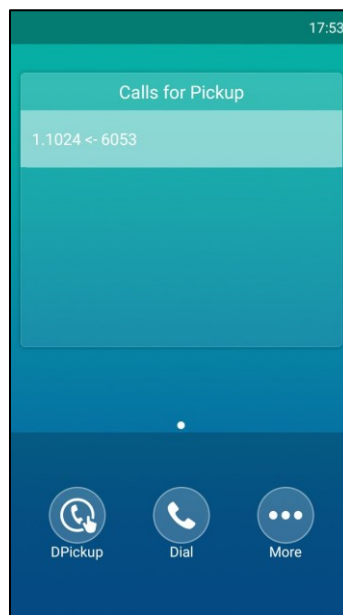

You can do the following actions:

- Tap **DPickup** to pick up the call.
- Tap **Dial** to dial out the monitored phone number.
- Tap **More->NewCall** to place a new call.
- Tap **More->Cancel** to exit this screen.

Configuring Transfer Mode via DssKey

When there is an active call on the IP phone, you can handle the active call differently depending on the configuration of the transfer mode via Dsskey with the BLF key.

To configure the transfer mode via Dsskey via web user interface:

1. Click on **Features->Transfer**.

2. Select the desired transfer mode from the pull-down list of **Transfer Mode via Dsskey**.
 - If you select **Blind Transfer**, tap the BLF key to blind transfer the call to the monitored user.
 - If you select **Attended Transfer**, tap the BLF key to dial out the monitored phone number and then perform an attended or a semi-attended transfer.
 - If you select **New Call**, tap the BLF key to place a new call to the monitored user.
The original call is placed on hold.

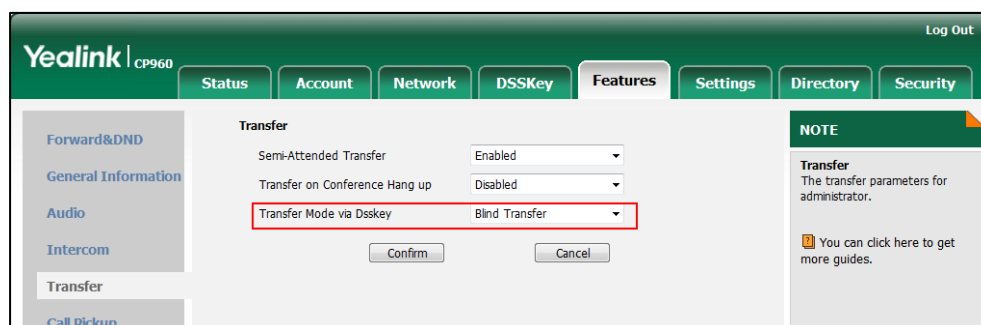

3. Click **Confirm** to accept the change.

Note Transfer Mode via DssKey is also applicable to BLF list feature.

Configuring Directed Call Pickup Code

If you configure the directed call pickup code in advance, you can pick up the monitored user's incoming call by tapping the BLF key. You can configure the directed call pickup code when configuring a BLF key. For more information, refer to [Configuring a BLF Key](#) on page 180. You can also configure the directed call pickup code on a global or per-line basis via web user interface.

If you enable visual alert feature, you can also pick up the monitored user's incoming call by tapping **DPickup**. To use **DPickup** to pick up the call, the call pickup code can only be configured on a global or per-line basis via web user interface.

Note The pickup code is used in the following order of preference: Extension (DSSKey->Line Key)>Directed Call Pickup Code (Account->Advanced)>Directed Call Pickup Code (Features->Call Pickup). If pickup code is not configured, tapping the BLF key/**DPickup** will directly call the monitored user when he/she receives an incoming call.

To configure directed call pickup feature on a global basis via web user interface:

1. Click on **Features->Call Pickup**.

2. Enter the desired pickup code in the **Directed Call Pickup Code** field.

The screenshot shows the 'Call Pickup' configuration page in the Yealink CP960 web interface. The 'Features' tab is selected. The 'Directed Call Pickup' field is set to 'Enabled'. The 'Directed Call Pickup Code' field is highlighted with a red box and contains the value '*97'. Other fields include 'Group Call Pickup' (Disabled), 'Group Call Pickup Code', 'Visual Alert for BLF Pickup' (Enabled), and 'Audio Alert for BLF Pickup' (Enabled). There are 'Confirm' and 'Cancel' buttons at the bottom.

3. Click **Confirm** to accept the change.

To configure the directed call pickup code on a per-line basis via web user interface:

1. Click on **Account->Advanced**.
2. Select the desired account from the pull-down list of **Account**.
3. Enter the desired pickup code in the **Directed Call Pickup Code** field.

The screenshot shows the 'Advanced' configuration page for an account in the Yealink CP960 web interface. The 'Account' dropdown is set to 'Account 1'. The 'Directed Call Pickup Code' field is highlighted with a red box and contains the value '*97'. Other fields include 'Keep Alive Type' (Default), 'Keep Alive Interval(Seconds)' (30), 'RPort' (Disabled), 'Subscribe Period(Seconds)' (1800), 'DTMF Type' (RFC2833), 'Music Server URI', 'Group Call Pickup Code', 'Distinctive Ring Tones' (Enabled), 'Unregister When Reboot' (Disabled), 'Out Dialog BLF' (Disabled), 'VQ RTPC-XR Collector name', 'VQ RTPC-XR Collector address', and 'VQ RTPC-XR Collector port' (5060). There are 'Confirm' and 'Cancel' buttons at the bottom.

4. Click **Confirm** to accept the change.

Using BLF Feature on the Phone

You can use the BLF key in the following ways:

- Place a call to the monitored user.
- Transfer a call to the monitored user.
- Pick up an incoming call of the monitored user.

Placing a Call to the Monitor User

You can tap a BLF key to dial out the monitored phone number when the monitored line is idle.

To place a call to the monitored user when the IP phone is idle:

1. Tap the BLF key.

The IP phone dials out the phone number of the monitored user.

Transferring a Call to the Monitored User

When there is already an active call on the IP phone, you can transfer the active call to the monitored user by tapping the BLF key. The phone handles the active call differently depending on the configuration of the transfer mode via Dsskey with the BLF key (refer to [Configuring Transfer Mode via DssKey](#)). The transfer mode via Dsskey has the following modes:

- Blind Transfer
- Attended Transfer
- New Call

To perform a blind transfer:

When the transfer mode via Dsskey is set to **Blind Transfer** and there is already an active call on the IP phone, you can do the following:

1. Tap **More->DSS Keys**.
2. Tap the BLF key of the monitored user which you want to transfer this call to.

Then the active call is connected to the number of the monitored user.

To perform a semi-attended transfer:

When the transfer mode via Dsskey is set to **Attended Transfer** and there is already an active call on the IP phone, you can do the following:

1. Tap **More->DSS Keys**.
2. Tap the BLF key of the monitored user which you want to transfer this call to. The phone will dial the number of the monitored user.
3. Tap the BLF key of the monitored user again or  to complete the transfer when receiving ringback.

To perform an attended transfer:

When the transfer mode via Dsskey is set to **Attended Transfer** and there is already an active call on the IP phone, you can do the following:

1. Tap **More->DSS Keys**.
2. Tap the BLF key of the monitored user which you want to transfer this call to. The phone will dial the number of the monitored user.
3. Tap the BLF key of the monitored user again or  to complete the transfer after the monitored user answers the call.

To perform a new call:

When the transfer mode via Dsskey is set to **New Call** and there is already an active call on the IP phone, you can do the following:

1. Tap **More->DSS Keys**.
2. Tap the BLF key of the monitored user you want to call.

The phone will dial the number of the monitored user. The original call is placed on hold.

Picking up an Incoming Call of the Monitored User

When the monitored user receives an incoming call, the BLF key icon of the monitored user will become  and flash. You can use the BLF key to pick up an incoming call of the monitored user. If you enable visual alert feature on the phone, you can pick up the incoming call using **DPickup**. Before picking up an incoming call, ensure that the directed call pickup code has been configured in advance.

To pick up an incoming call using the BLF key or the DPickup:

1. Tap the BLF key or the **DPickup**.

The incoming call of the monitored user is answered on the IP phone.

Note

If the directed call pickup code is not configured, the phone will place a call to the monitored user instead of picking up an incoming call of the monitored user when you tap the BLF key or **DPickup**.

BLF List

You can use the BLF List feature to monitor a list of users defined by your system administrator. For example, your system administrator enables BLF List, and creates a BLF List URI (e.g., BLFList@example.com) including a list of user1, user2 on the server. The BLF List keys on the IP phone can present the status of user1 and user2. The key icons illuminate flashing or solid depending on the status of those users. For more BLF List key icon, refer to [Icon indicator \(associated with BLF/BLF List\)](#) on page 17.

You can use the BLF List keys in the following ways:

- When the monitored user is idle, tap the BLF list key to dial out the phone number.
- When there is already an active call on the IP phone, you can transfer the active call to the monitored user by tapping the BLF List key. The phone handles the active call differently depending on the configuration of the transfer mode via Dsskey with the BLF list key. For more information on the transfer mode via Dsskey, refer to [Configuring Transfer Mode via DssKey](#) on page 182.
- When the monitored user receives an incoming call, tap the BLF list key to pick up the call directly. Before picking up an incoming call, ensure that the BLF List Pickup Code has been configured in advance. If the code is not configured, the phone will place a call to the

monitored user instead of picking up the incoming call of the monitored user when you tap the BLF List key.

- When there is a conversation on the monitored user, tap the BLF list key to barge in and set up a conference call. Before barging in an active call, ensure that the BLF List Barge In Code has been configured in advance. If the code is not configured, the phone will place a call to the monitored user instead of barging in an active call of the monitored user when you tap the BLF List key.
- When a call is being parked against the monitored phone, tap the BLF List key to retrieve the parked call from the monitored user. Before retrieving the parked call, ensure that the BLF List Retrieve Call Parked Code has been configured in advance. If the code is not configured, the phone will place a call to the monitored user instead of retrieving the parked call when you tap the BLF List key.

To configure BLF List settings via web user interface:

1. Click on **Account->Advanced**.
2. Select the desired account from the pull-down list of **Account**.
3. Enter the BLF List URI in the **BLF List URI** field.
4. (Optional.) Enter the directed pickup code in the **BLF List Pickup Code** field.
5. (Optional.) Enter the barge-in code in the **BLF List Barge In Code** field.
6. (Optional.) Enter the call park retrieve code in the **BLF List Retrieve Call Parked Code** field.

The screenshot shows the Yealink CP960 web interface. The top navigation bar includes 'Status', 'Account', 'Network', 'DSSKey', 'Features', 'Settings', 'Directory', and 'Security'. The 'Account' section is active, showing 'Account 1' selected. The 'Advanced' tab is selected in the left sidebar. The main content area displays various configuration fields for the account. A red box highlights the following fields:

BLF List URI	4609@yealink.com
BLF List Pickup Code	*97
BLF List Barge In Code	*33
BLF List Retrieve Call Parked Code	*88

Other visible fields include: Keep Alive Type (Default), Keep Alive Interval(Seconds) (30), RPort (Disabled), Subscribe Period(Seconds) (1800), DTMF Type (RFC2833), PTime(ms) (20), Shared Line (Disabled), VQ RTPC-XR Collector address, and VQ RTPC-XR Collector port (5060). A 'NOTE' box on the right states: 'Advanced The Advanced parameters for administrator. You can click here to get more guides.' At the bottom, there are 'Confirm' and 'Cancel' buttons.

7. Click **Confirm** to accept the change.

Note

For more information on BLF List URI/BLF List Pickup Code/BLF List Barge In Code/BLF List Retrieve Call Parked Code, contact your system administrator.

According to the response message from the server, the IP phone will automatically configure the BLF List keys beginning from the first unused DSS key. Once any DSS key is seized, the IP phone will skip to configure the next DSS key.

You can receive a visual or/and an audio alert (if enabled) on your phone when the monitored user receives an incoming call. For more information, refer to [Configuring Visual and Audio Alert for BLF pickup](#) on page 181.

Note

The pickup code is used in the following order of preference: BLF List Pickup Code (Account->Advanced)>Directed Call Pickup Code (Account->Advanced)>Directed Call Pickup Code (Features->Call Pickup). If all of them are not configured, tapping the BLF List key will directly call the monitored user when he/she receives an incoming call. For more information about pickup code, refer to [Call Pickup](#) on page 171.

Call Recording

Before recording any call, especially those involving PSTN, it is necessary to know about the rules and restrictions of any governing call-recording in the place you are in. It is also very important to have the consent of the person you are calling before recording the conversation.

Call and Conference Recording (Local)

You can record active calls or conferences by tapping  on your phone, and you can record up to 12 hours in one file. You can set a mark while recording. This feature is useful during important meetings or discussions, allowing you to mark some pivotal points in the discussion that you'll need to reference later.

The recorded calls saved in *.aac format and include a date & time stamp and the other party's number/IP address/name (or the first person's number/IP address/name you called), for example, 20170515-1452-Tom was created on May 15, 2017, at 14:52 and you have a call with Tom.

By default, the recorded files are saved in the internal SD card. You can connect a USB flash drive to your phone, and save the recorded audios to the connected USB flash drive. For more information on how to connect a USB flash drive, refer to [Connect the Optional USB Flash Drive](#) on page 29.

Note

If you use a record key to record a call, the recorded file will be stored in servers. For more information, refer to [Call Recording \(Server Side\)](#) on page 191.

The  controls the recording function, and is available:

- When there are one or more calls connected to your phone
- During an active call

- When calls are muted
- During an attended transfer
- During a conference call

The  is not available:

- When there are no connected calls on your phone
- When you place a new call (to transfer or to conference)
- When the phone prompts you to answer an incoming call

The recording is not be paused when the following occurs:

- You place a call on hold.
- You mute a call.
- You set up a conference call
- You perform the semi-attended or attended transfer
- An incoming calls arrives on your phone



Call Recording

To record a call via phone user interface:

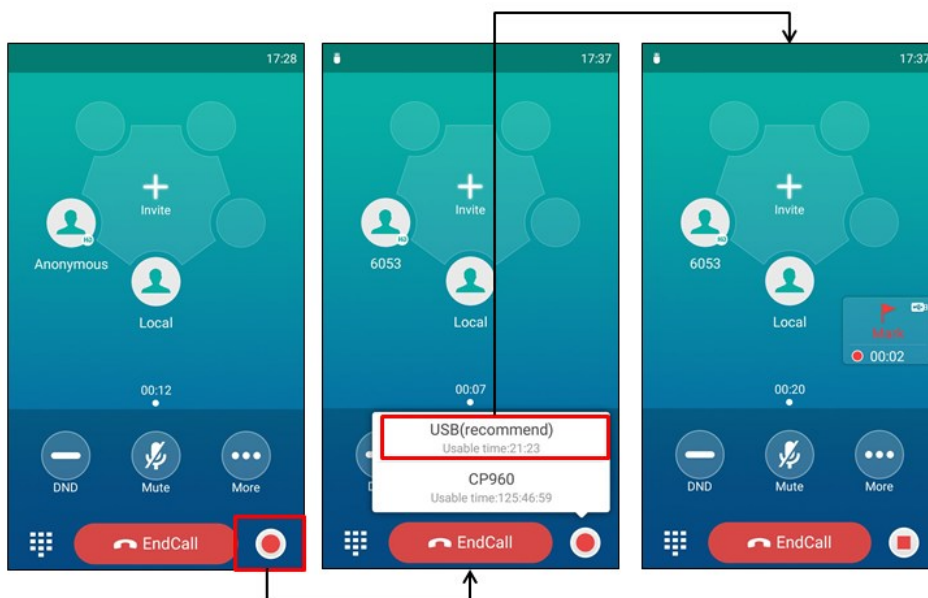
1. Tap 
2. If a USB flash drive is connected, select where to save your recording.
In this example, the recording will be saved to USB flash drive.



The record icon changes to  the record duration and a mark flag appear on the touch screen.

3. (Optional.) Tap  to set a mark. The icon changes to , the number will increase if you set more marks. And there is a red flag on this moment when playing the recorded file. If you hold the call while recording, only you are recorded. If you mute the call while recording, only the callee is recorded.

When you end a call while recording, the recording will be stopped and saved automatically.

To stop recording while the phone records, do one of the following:

- Tap  during a call. The status bar prompts "Record call successfully on device".

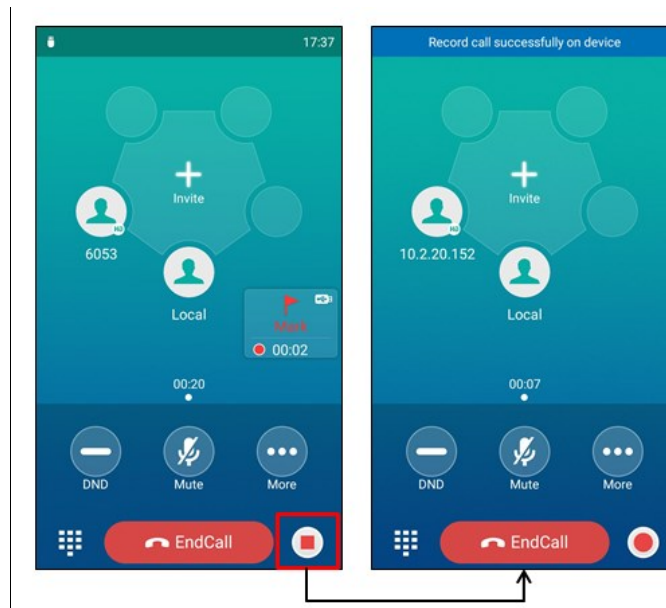

- When there is only a call on the phone, tap **EndCall**. The recording will be stored as a new file when the phone starts recording again.

Conference Recording

You can record conference calls in the same way as other calls with the following exceptions:

- All conference participants are recorded while recording. If one of the participants holds the conference call, only that participant is recorded. When a conference call is placed on hold, recording of the conference is paused. You can place or answer other calls, which will be recorded in the same file. When the conference call is resumed, recording of the conference resumes.
- All conference participants are recorded while recording. If one of the participants mutes the conference call, only that participant is not recorded.

Call Recording (Server Side)

You can record calls by tapping a record key on the phone. The CP960 IP phone supports record and URL record.

Two ways of call recording:

- **Record:** The phone sends a SIP INFO message containing a specific header "Record: on/off" to trigger a recording.
- **URL Record:** The phone sends an HTTP URL request to trigger a recording. Contact your system administrator for the predefined URL.

Note

If you record a call locally, the recorded file will be stored in the IP phone or USB flash drive. For more information, refer to [Call and Conference Recording \(Local\)](#) on page 188.

Call recording is not available on all servers. Contact your system administrator for more information.

To configure a record key via phone user interface:

1. Tap **Settings** from the Home screen.
2. Tap **DSS Keys** from the **Features** block.
3. Tap the desired line key.
4. Tap the **Type** field.
5. Tap **Key Event** in the pop-up dialog box.
6. Tap the **Key Type** field.
7. Tap **Record** in the pop-up dialog box.
8. (Optional.) Enter the string that will appear on the touch screen in the **Label** field.



9. Tap to accept the change or to cancel.

To configure a URL record key via phone user interface:

1. Tap **Settings** from the Home screen.
2. Tap **DSS Keys** from the **Features** block.
3. Tap the desired line key.
4. Tap the **Type** field.

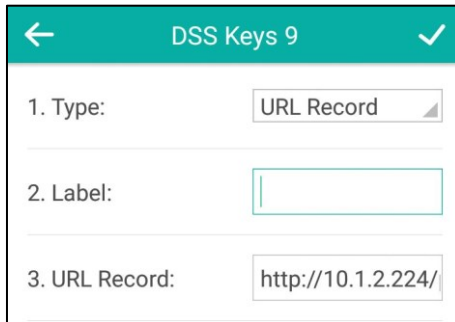
5. Tap **URL Record** in the pop-up dialog box.
6. (Optional.) Enter the string that will appear on the touch screen in the **Label** field.
7. Enter the URL (e.g., http://10.1.2.224/phonerecording.cgi) in the **URL Record** field.



8. Tap  to accept the change or  to cancel.

Record and URL record keys are configurable via web user interface at the path **DSSKey->Line Key**.

The Record and URL Record keys control the recording function, and are available:

- During an active call
- When calls are on hold or muted
- During a conference call

The Record and URL Record keys are not available when:

- There are no connected calls on your phone
- You place a new call

To record a call:



1. Tap **More->DSS Key** during a call.
2. Tap the Record key or URL Record key.



If the recording starts successfully, the recording icon will appear at the bottom-right corner of the contact avatar and the icon indicator of the Record key or URL Record key will change to .

3. Tap the Record key or URL Record key again to stop recording.

The recording icon disappears from the bottom-right corner of the contact avatar and the icon indicator of the Record key or URL Record key changes to .

Recording status indications you need to know:

Circumstance	Icons on the touch screen
A recording is started	 appears on the touch screen
A recording cannot be started	 appears for 1 second

Circumstance	Icons on the touch screen
A recording cannot be stopped	 appears for 1 second, then goes back
The recording box is full	 appears for 1 second
The call cannot be recorded	 appears for 1 second

You can listen to the recordings stored on your server system. For example, you can dial an access code to listen to the recordings.

Note

The way in which you listen to the recordings may be different depending on the server. Contact your system administrator for more information.

Hot Desking

Hot desking originates from the definition of being the temporary physical occupant of a work station or surface by a particular employee. A primary motivation for hot desking is cost reduction. This feature is regularly used in places where not all the employees are in the office at the same time, or not in the office for very long, which means that actual personal offices would be often vacant, consuming valuable space and resources.

You can use hot desking on the CP960 IP phone to log out of existing accounts and then log into a new account. As a result, many users can share the phone resource at different times. To use this feature, you need to configure a hot desking key in advance.

Note

Hot desking is not available on all servers. Contact your system administrator for more

To configure a hot desking key via phone user interface:

1. Tap **Settings** from the Home screen.
2. Tap **DSS Keys** from the **Features** block.
3. Tap the desired line key.
4. Tap the **Type** field.
5. Tap **Key Event** in the pop-up dialog box.
6. Tap the **Key Type** field.
7. Tap **Hot Desking** in the pop-up dialog box.

- (Optional.) Enter the string that will appear on the touch screen in the **Label** field.

- Tap to accept the change or to cancel.

Hot desking key is configurable via web user interface at the path **DSSKey->Line Key**.

To use hot desking:

- Tap the hot desking key from the DSS key screen.

The following prompt will appear on the touch screen of the phone:

- Tap **OK**.

Registration configurations of all accounts on the phone will be cleared immediately.

The login wizard will be displayed as below:

- Enter the login information in each field.
- Tap to accept the change or to cancel.

Intercom

Intercom is a useful feature in an office environment to quickly connect with the operator or the secretary. You can tap the intercom key to automatically connect with a preconfigured target extension for outgoing intercom calls, and the target extension will automatically answer incoming intercom calls by default. You can also use intercom key to monitor the target extension for status changes on the phone.

Note Intercom is not available on all servers. Contact your system administrator for more information.

Configuring the Intercom Feature on the Phone

Configuring an Intercom Key



To configure an intercom key via phone user interface:

1. Tap **Settings** from the Home screen.
2. Tap **DSS Keys** from the **Features** block.
3. Tap the desired line key.
4. Tap the **Type** field.
5. Tap **Intercom** in the pop-up dialog box.
6. Tap the **Account ID** field.
7. Tap the desired line in the pop-up dialog box.
8. (Optional.) Enter the string that will appear on the touch screen in the **Label** field.
9. Enter the target extension number in the **Value** field.
10. (Optional.) Enter the directed call pickup code in the **Extension** field.

If it is configured, when the target extension receives an incoming call, you can tap the intercom key to pick up the call directly. Contact your system administrator for more information.

The screenshot shows a configuration screen titled "DSS Keys 2" with a back arrow on the left and a checkmark on the right. The screen contains five numbered fields:

- 1. Type: A dropdown menu with "Intercom" selected.
- 2. Account ID: A dropdown menu with "Line 1" selected.
- 3. Label: An empty text input field.
- 4. Value: A text input field containing "6054".
- 5. Extension: An empty text input field.

11. Tap  to accept the change or  to cancel.

Intercom key is configurable via web user interface at the path **DSSKey->Line Key**.

Incoming Intercom Calls

The CP960 IP phone supports automatically answering an incoming intercom call by default. The phone automatically plays a warning tone when it receives an incoming intercom call. In addition, you can enable the phone to mute the microphone when it automatically answers an incoming intercom call. You can also enable the phone to automatically answer an incoming intercom call while there is already an active call on the phone. The active call is then placed on hold.

Accept Intercom

You can enable or disable the phone to automatically answer an incoming intercom call. If Accept Intercom is enabled, the phone will automatically answer an incoming intercom call. If Accept Intercom is disabled, the phone will reject incoming intercom calls and send a busy message to the caller. Accept Intercom is enabled by default.

Note

Your administrator can set a period of delay time before the phone automatically answers intercom calls. Contact your system administrator for more information.

Intercom Mute

You can mute or unmute the phone's microphone for intercom calls automatically. If Intercom Mute is enabled, the microphone will be muted for intercom calls. If Intercom Mute is disabled, the microphone will work for intercom calls. Intercom Mute is disabled by default.

Intercom Tone

You can enable or disable the phone to play a warning tone when receiving an intercom call. If Intercom Tone is enabled, the phone will play a warning tone before answering the intercom call. If Intercom Tone is disabled, the phone will automatically answer the intercom call without warning. Intercom Tone is enabled by default.

Intercom Barge

You can enable or disable the phone to automatically answer an incoming intercom call while there is already an active call on the phone. If Intercom Barge is enabled, the phone will automatically answer the intercom call and place the active call on hold. If Intercom Barge is disabled, the phone will handle an incoming intercom call like a waiting call. Intercom Barge is disabled by default.



Note

To enable the phone to receive a new incoming call when it has an active call, make sure that call waiting feature is enabled on the phone in advance. For more information, refer to [Call Waiting](#) on page 161.

To configure intercom features via phone user interface:

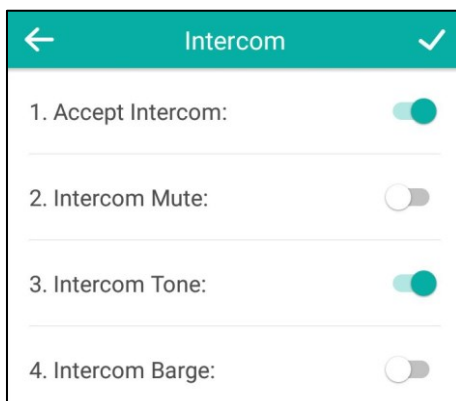
1. Tap **Settings** from the Home screen.
2. Tap **Intercom** from the **Features** block.
3. Make the desired changes.



4. Tap  to accept the change or  to cancel.

These specific parameters are configurable via web user interface at the path **Features->Intercom**.

Using Intercom Feature on the Phone

You can use the intercom key in the following ways:

- Place a call to the target extension.
- Pick up an incoming call of the target extension.

Placing an Intercom Call to the Target Extension

To place an intercom call when the target phone is idle:

1. Tap the intercom key.

The target extension plays a warning tone and automatically answers the call in the hands-free (speakerphone) mode by default.

Picking up an Incoming Call of the Target Extension

When the target extension receives an incoming call, the intercom key icon of the target extension will become  and stay solid. If you configure the directed call pickup code in advance, you can pick up the target extension's incoming call by tapping the intercom key. You can configure the directed call pickup code when configuring an intercom key. For more information, refer to [Configuring an Intercom Key](#) on page 195.

To pick up an incoming call when the target phone is ringing:

1. Tap the intercom key.

The incoming call of the target extension is answered on the IP phone.

Note

If the directed call pickup code is not configured, the phone will place a call to the target extension instead of picking up an incoming call of the target extension when you tap the intercom key.

Multicast Paging

You can use multicast paging to quickly and easily broadcast time sensitive announcements out to people who are listening to a specific multicast group and a specific channel. You can configure a multicast paging key or a paging list key on the phone, which allows you to send a Real Time Transport Protocol (RTP) stream to the pre-configured multicast address(es) and channel(s) without involving SIP signaling. You can configure the phone to receive an RTP stream from pre-configured multicast listening address(es) and channel(s) without involving SIP signaling. You can specify up to 31 multicast listening addresses and channel(s) .

The following describes 31 paging channels:

- **0:** You can broadcast audio to channel 0. Note that the Yealink IP phones running old firmware version (old paging mechanism) can be regarded as listening to channel 0. It is the default channel.
- **1 to 25:** You can broadcast audio to a specific channel. We recommend that you specify these channels when broadcasting with Polycom IP phones which have 25 channels you can listening to.
- **26 to 30:** You can broadcast audio to a specific channel. We recommend that you specify these channels when broadcasting with Yealink IP phones running new firmware version (new paging mechanism).

The IP phones will automatically ignore all incoming multicast paging calls on the different channels.

Sending RTP Stream

To configure a multicast paging key via phone user interface:

1. Tap **Settings** from the Home screen.
2. Tap **DSS Keys** from the **Features** block.
3. Tap the desired line key.
4. Tap the **Type** field.
5. Tap **Key Event** in the pop-up dialog box.
6. Tap the **Key Type** field.
7. Tap **Multicast Paging** in the pop-up dialog box.
8. (Optional.) Enter the string that will appear on the touch screen in the **Label** field.

9. Enter the multicast IP address and port number (e.g., 224.5.6.20:10008) in the **Value** field.
The valid multicast IP addresses range from 224.0.0.0 to 239.255.255.255.
10. Enter the desired channel in the **Channel** field.
The valid channel ranges from 0 to 30.

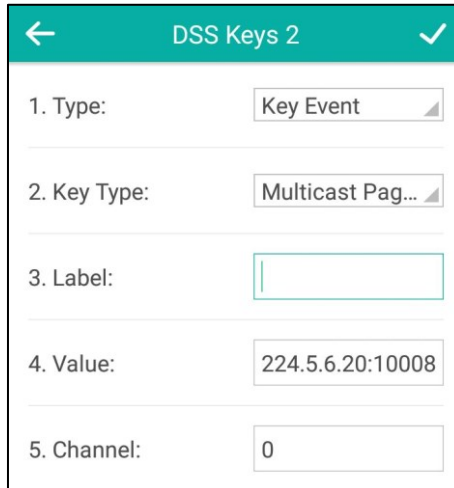

11. Tap ✓ to accept the change or ← to cancel.

Multicast paging key is configurable via web user interface at the path **DSSKey->Line Key**.

To configure a paging list key via phone user interface:

1. Tap **Settings** from the Home screen.
2. Tap **DSS Keys** from the **Features** block.
3. Tap the desired line key.
4. Tap the **Type** field.
5. Tap **Key Event** in the pop-up dialog box.
6. Tap the **Key Type** field.
7. Tap **Paging List** in the pop-up dialog box.
8. (Optional.) Enter the string that will appear on the touch screen in the **Label** field.

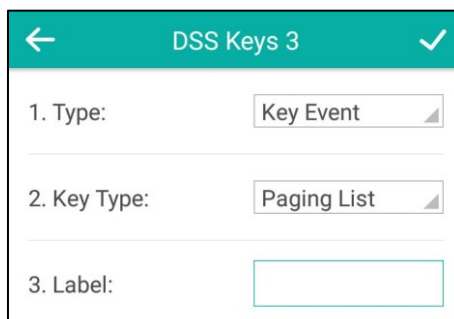

9. Tap ✓ to accept the change or ← to cancel.

Paging list key is configurable via web user interface at the path **DSSKey->Line Key**.

To configure paging list via phone user interface:

1. Tap the paging list key from the DSS key screen.
If the paging list key is not configured, you can also tap **Settings** from the Home screen. Then tap **Paging List** from the **Features** block to configure the paging list.



2. Tap  after the desired paging group.
3. Enter the multicast IP address and port number (e.g., 224.5.6.20:10008) in the **Address** field.

The valid multicast IP addresses range from 224.0.0.0 to 239.255.255.255.

4. Enter the paging group name in the **Label** field.
5. Enter the desired channel in the **Channel** field.

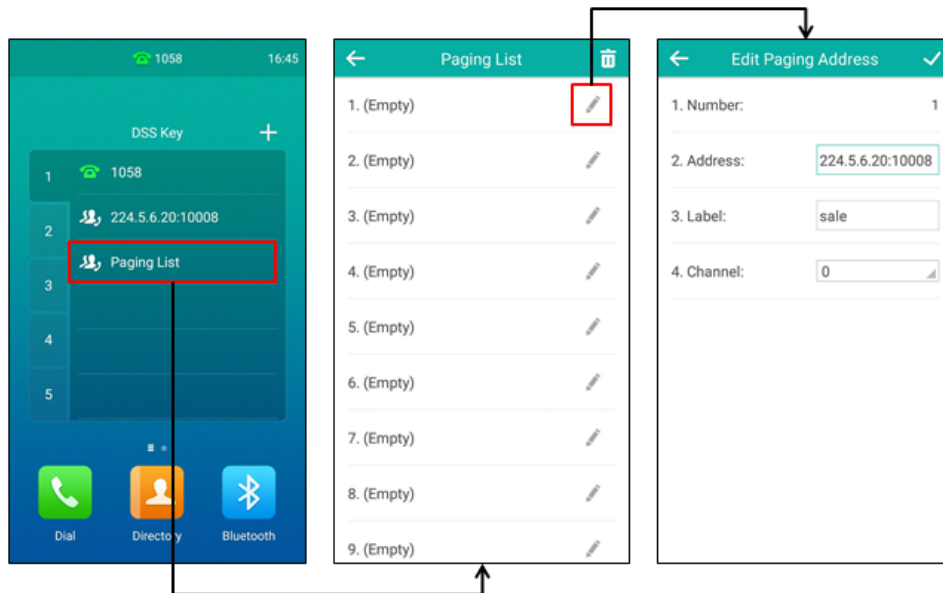

The valid channel ranges from 0 to 30.



6. Tap  to accept the change or  to cancel.
7. Repeat steps 2 to 7, you can add more paging groups.

Paging list is configurable via web user interface at the path **Directory->Multicast IP**.

To delete paging group via phone user interface:

1. Tap the paging list key from the DSS key screen.
2. Tap  after the desired paging group.
The icon  only appears after the configured paging group.

3. Tap **Delete**.

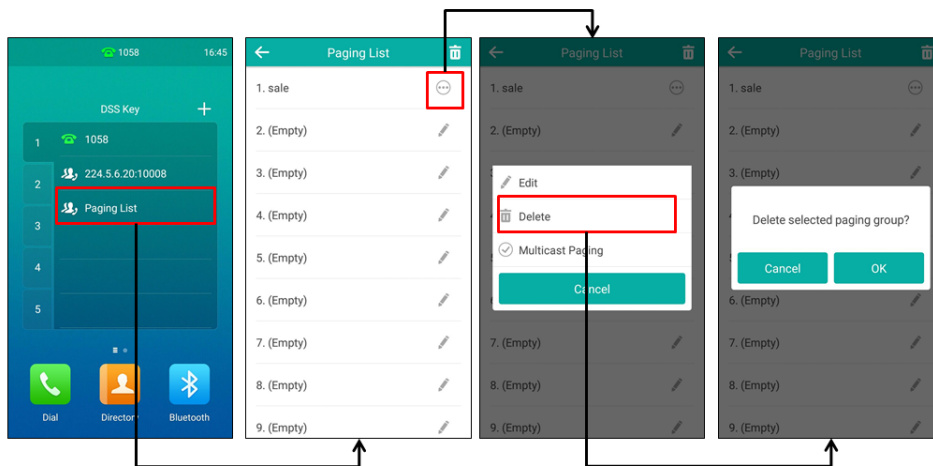

4. Tap **OK** to accept the change or **Cancel** to cancel.

If you want to delete all paging groups, you can tap  on the top-right of the touch screen.

You can also configure the phone to use a default codec for sending multicast RTP stream via web user interface.

To configure a default codec for multicast paging via web user interface:

1. Click on **Features->General Information**.
2. Select the desired codec from the pull-down list of **Multicast Codec**.

The default codec is G722.

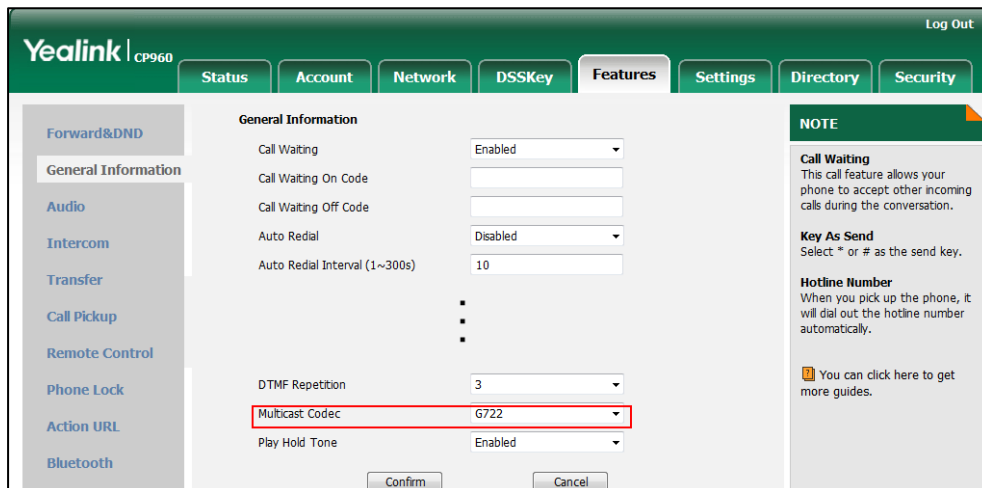

3. Click **Confirm** to accept the change.

Note

If G722 codec is used for multicast paging, the touch screen will display the icon  to indicate that it is providing high definition voice.

Default codec for multicast paging is configurable via web user interface only.

Receiving RTP Stream

You can configure the phone to receive a Real Time Transport Protocol (RTP) stream from the pre-configured multicast address(es) and channel(s) without involving SIP signaling. You can specify up to 31 multicast addresses and channel(s) that the phone listens to on the network.

Note

RTP stream is listened in the hands-free (speakerphone) mode by default. If you want to listen the RTP stream using the engaged audio device (speakerphone, handset or headset), contact your system administrator for more information.

Fixed volume to play RTP stream for specified paging group is configurable by your system administrator.

How the phone handles incoming multicast paging calls depends on Paging Barge and Paging Priority Active parameters configured via web user interface.

Paging Barge

The paging barge parameter defines the priority of the voice call in progress. If the priority of an incoming multicast paging call is lower than that of the active call, it will be ignored automatically. If Disabled is selected from the pull-down list of Paging Barge, the voice call in progress will take precedence over all incoming multicast paging calls. Valid values in the Paging Barge field:

- **1 to 31:** Define the priority of the active call, 1 with the highest priority, 31 with the lowest.
- **Disabled:** The voice call in progress will take precedence over all incoming paging calls.

Paging Priority Active

The paging priority active parameter decides how the phone handles incoming multicast paging calls when there is already a multicast paging call on the phone. If enabled, the phone will ignore incoming multicast paging calls with lower priorities, otherwise, the phone will answer incoming multicast paging calls automatically and place the previous multicast paging call on hold. If disabled, the phone will automatically ignore all incoming multicast paging calls.

To configure multicast listening addresses via web user interface:

1. Click on **Directory->Multicast IP**.
2. Select the desired value from the pull-down list of **Paging Barge**.
3. Select the desired value from the pull-down list of **Paging Priority Active**.
4. Enter the multicast IP address(es) and port number (e.g., 224.5.6.20:10008) which the phone listens to for incoming RTP multicast in the **Listening Address** field.
5. (Optional.) Enter the label in the **Label** field.

Label will appear on the touch screen when receiving the multicast RTP stream.

- Select the desired channel to listen from the pull-down list of **Channel**.

The default channel is 0.

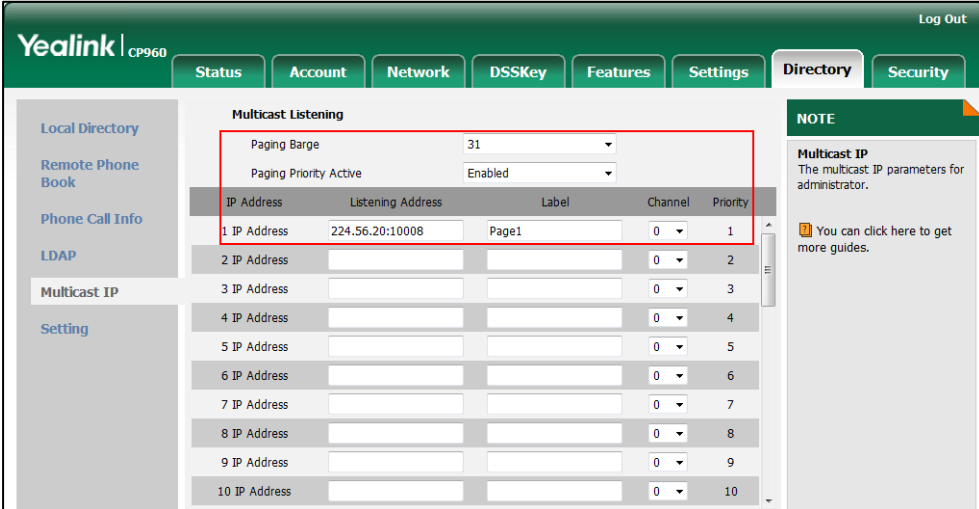

Multicast Listening

Paging Barge: 31

Paging Priority Active: Enabled

IP Address	Listening Address	Label	Channel	Priority
1 IP Address	224.56.20:10008	Page1	0	1
2 IP Address			0	2
3 IP Address			0	3
4 IP Address			0	4
5 IP Address			0	5
6 IP Address			0	6
7 IP Address			0	7
8 IP Address			0	8
9 IP Address			0	9
10 IP Address			0	10

NOTE
Multicast IP
 The multicast IP parameters for administrator.
 You can click here to get more guides.

- Click **Confirm** to accept the change.

Note The priorities of listening addresses are predefined: 1 with the highest priority, 31 with the lowest. Multicast listening addresses are configurable via web user interface only.

Using Multicast Paging

To send RTP stream via a multicast paging key when the receiver's phone is idle:

- Tap the multicast paging key from the DSS key screen.



The phone sends RTP to a preconfigured multicast address (IP: Port).

Both the sender's and receiver's phones play a warning tone and the receiver automatically answers the multicast RTP session in the hands-free (speakerphone) mode.

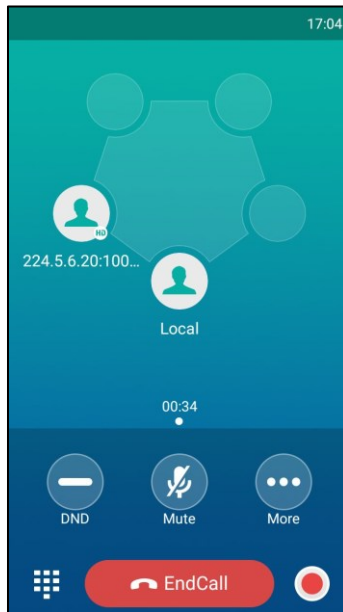
The following figure shows a multicast RTP session on the phone:



2. You can do the following:

- Tap **More->Hold** to place the current multicast RTP session on hold.
The sender's phone places the multicast RTP session on hold and receiver's phone releases the session.
To resume the held multicast RTP session, tap **Resume** or tap **More->Resume**.
The multicast RTP session is established again.
- Tap **DND** to enable or disable DND mode.
- Tap **Mute** to mute the multicast RTP session, all other participants can hear each other, but they cannot hear you.
- Tap **EndCall** to cancel the multicast RTP session.
- Tap  to record a call.
To stop recording, tap .

Note

Multicast RTP is one way only from the sender to the multicast address(es) (receiver). For outgoing RTP multicasts, all other existing calls on the phone will be placed on hold.

To send RTP stream via a paging key list when the receiver's phone is idle:

1. Tap paging list key from the DSS key screen.
2. Do one of the following to send RTP:
 - Tap the desired paging group.
 - Tap  after the desired paging group, and then tap **Multicast Paging**.

3. You can do the following:

- Tap **More->Hold** to place the current multicast RTP session on hold.

The sender's phone places the multicast RTP session on hold and receiver's phone releases the session.

To resume the held multicast RTP session, tap  or tap **More->Resume**.

The multicast RTP session is established again.

- Tap **DND** to enable or disable DND mode.
- Tap **Mute** to mute the multicast RTP session, all other participants can hear each other, but they cannot hear you.
- Tap **EndCall** to cancel the multicast RTP session.

- Tap  to record a call.

To stop recording, tap 

Music on Hold

Music on hold (MoH) is the business practice of playing recorded music to fill the silence that would be heard by the party placed on hold. To use this feature, you should specify a SIP URI pointing to a Music on Hold Server account. When a call is placed on hold, the phone will send a SIP INVITE message to the Music on Hold Server account. The Music on Hold Server account automatically answers the SIP INVITE messages and immediately plays audio from some source located anywhere (LAN, Internet) to the held party. Contact your system administrator for the SIP URI.

To configure music on hold server via web user interface:

1. Click on **Account->Advanced**.
2. Select the desired account from the pull-down list of **Account**.

- Enter the SIP URI (e.g., sip:moh@sip.com) in the **Music Server URI** field.

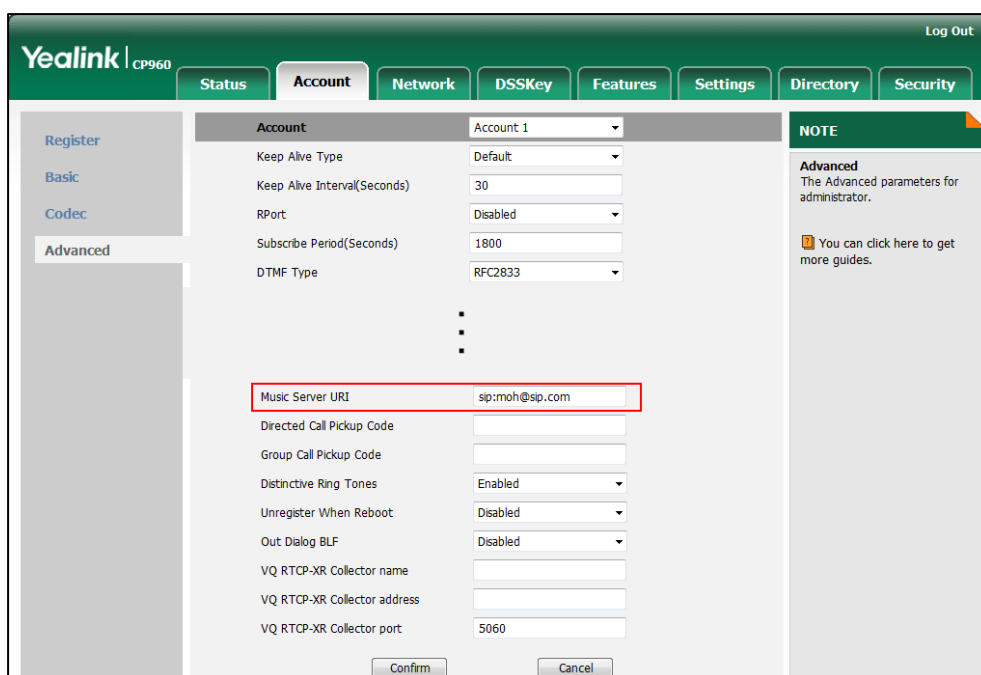

- Click **Confirm** to accept the change.

When you place a call on hold, music will be played to the held party.

Note

For this feature to function, all involved parties cannot use encrypted RTP (SRTP).
 Music on hold server is configurable via web user interface only.

Shared Call Appearance (SCA)

You can use SCA feature to share an extension which can be registered on two or more IP phones at the same time. The shared line is indicated by a different line icon.

In the following figure, the registered line is shared:

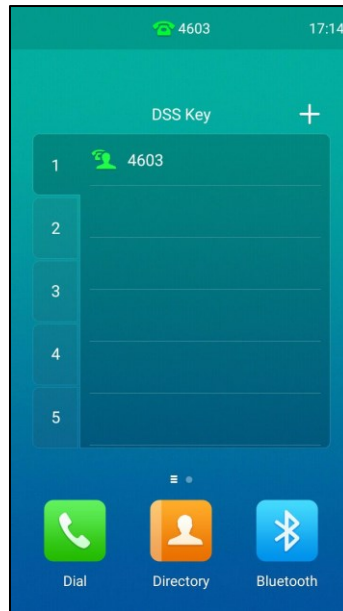

If two phones share a line, an incoming call to this extension will cause both phones to ring simultaneously. The incoming call can be answered on either phone but not both.

This feature is very useful in the boss and secretary scenario. For example, the secretary can share the boss's extension on her phone. When there is an incoming call to the extension of the boss, both the phones of the boss and the secretary will ring simultaneously. Either the boss or the secretary can answer the call. Calls on the shared line can be placed on hold, barged in or retrieved from another shared phone.

Configuring SCA Feature on the IP Phone

You can configure a primary account on the IP phone and other alternate accounts on the other IP phones. In a SCA Hybrid Key System scenario, you can automatically assign multiple DSS keys with Line type for a registered shared line on the phone (If auto linekeys feature is enabled). For example, party A, party B share the account 4603, phone A registers the primary account 4603 and assigns line key 1 and line key 2 for the account 4603, phone B registers the alternate account 4603_1 and assigns line key 1 and line key 2 for the account 4603_1, phone C registers the account 4604.

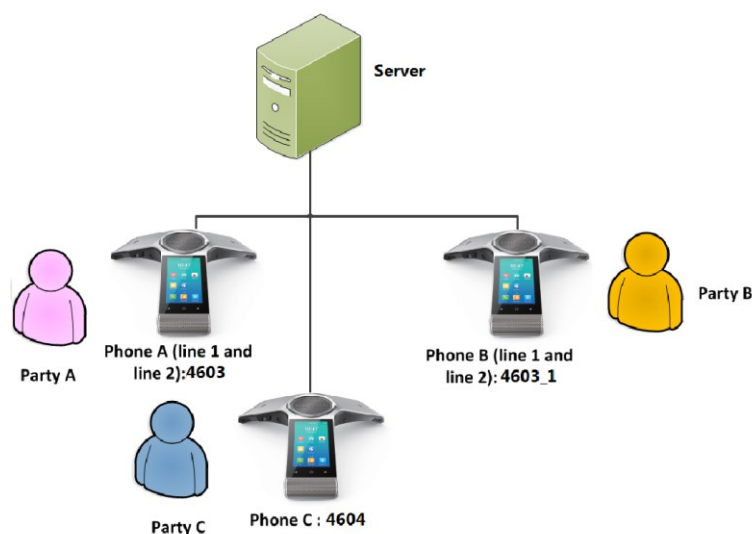

To configure the auto linekeys feature via web user interface:

1. Click on **Features-> General Information**.
2. Select **Enabled** from the pull-down list of **Auto LineKeys**.

If **Auto LineKeys** is enabled, you can automatically assign multiple DSS keys with Line type for a registered shared line on the phone.

The screenshot shows the Yealink CP960 web user interface. The 'Features' tab is selected, and the 'General Information' section is expanded. The 'Auto Linekeys' option is highlighted with a red box and set to 'Enabled'. Other options include Call Waiting (Enabled), Auto Redial (Disabled), and Hotline Delay (4). A 'NOTE' section on the right provides information about Call Waiting, Key As Send, and Hotline Number.

3. Click **Confirm** to accept the change.

To configure the shared line settings and the number of line key on phone A via web user interface:

1. Register the primary account 4603.

The screenshot shows the Yealink CP960 web interface. The 'Account' tab is selected, and the 'Advanced' sub-tab is active. The 'SIP Server 1' section is highlighted with a red box, showing fields for Line Active (Enabled), Label (4603), Display Name (4603), Register Name (4603), User Name (4603), Password (masked), Server Host (pbx.yealink.com), and Port (5060). The 'Enable Outbound Proxy Server' section is also highlighted with a red box, showing fields for Enable Outbound Proxy Server (Enabled), Outbound Proxy Server 1 (10.1.8.11), and Port (5060). A 'NOTE' section on the right provides definitions for Display Name, Register Name, User Name, and NAT Traversal.

2. Click on **Advanced**, and then select **Share Call Appearance** from the pull-down list of **Shared Line**.
3. Enter the desired number in the **Number of line key** field.
This field appears only if **Auto Linekeys** feature is enabled.

The default value is 1. In this example, the value is set to 2.

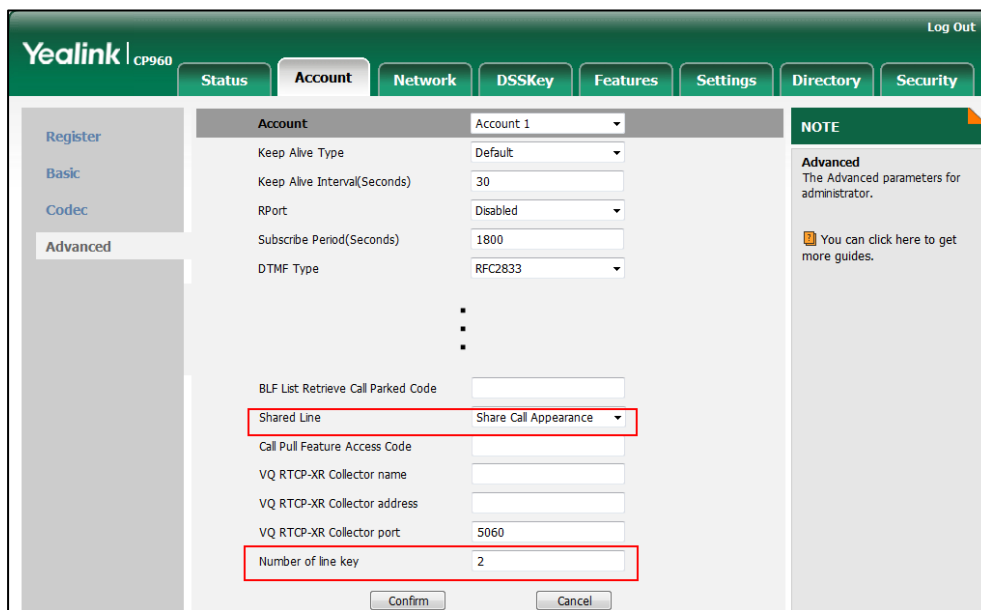

4. Click **Confirm** to accept the change.

The phone A will automatically configure the line keys from the first unused DSS key, according to the configured number in the **Number of line key** field.

To configure the shared line settings and the number of line key on phone B via web user interface:

1. Register the alternate account 4603_1.
(Enter the primary account 4603 in the **Register Name** field.)

The screenshot shows the Yealink CP960 web interface for configuring an account. The 'Account' tab is selected, and the account is 'Account 1'. The 'Register' section shows the account is 'Registered'. The 'Line Active' section is highlighted with a red box, showing 'Line Active' set to 'Enabled', 'Label' as '4603_1', 'Display Name' as '4603_1', 'Register Name' as '4603', 'User Name' as '4603_1', and 'Password' as '*****'. The 'SIP Server 1' section shows 'Server Host' as 'pbx.yealink.com' and 'Port' as '5060'. The 'SIP Server 2' section shows 'Server Host' as empty and 'Port' as '5060'. The 'Outbound Proxy Server' section is highlighted with a red box, showing 'Enable Outbound Proxy Server' set to 'Enabled', 'Outbound Proxy Server 1' as '10.1.8.11', and 'Outbound Proxy Server 2' as empty. The 'NAT' section shows 'NAT' set to 'Disabled'. A 'NOTE' section on the right provides definitions for 'Display Name', 'Register Name', 'User Name', and 'NAT Traversal'. A 'Log Out' link is in the top right corner.

2. Click on **Advanced**, and then select **Share Call Appearance** from the pull-down list of **Shared Line**.
3. Enter the desired number in the **Number of line key** field.
This field appears only if **Auto Linekeys** feature is enabled.

The default value is 1. In this example, the value is set to 2.

The screenshot shows the Yealink CP960 web interface. The 'Account' tab is selected, and the 'Advanced' sub-tab is active. The 'Number of line key' field is highlighted with a red box and contains the value '2'. Other fields include 'Keep Alive Type' (Default), 'Keep Alive Interval(Seconds)' (30), 'RPort' (Disabled), 'Subscribe Period(Seconds)' (1800), 'DTMF Type' (RFC2833), 'Shared Line' (Share Call Appearance), 'Call Pull Feature Access Code', 'VQ RTPC-XR Collector name', 'VQ RTPC-XR Collector address', and 'VQ RTPC-XR Collector port' (5060). A 'NOTE' box on the right indicates that advanced parameters are for administrators and provides a link for more guides. 'Confirm' and 'Cancel' buttons are at the bottom.

4. Click **Confirm** to accept the change.

The phone B will automatically configure the line keys from the first unused DSS key, according to the configured number in the **Number of line key** field.

Configuring a Private Hold Key

Public hold allows any shared line to retrieve the held call. Private hold only allows the hold party to retrieve the held call. For example, you can retrieve the held call on either phone A or phone B when you place a call on public hold; you can retrieve the held call only on phone A when you place a call on private hold on phone A. You need to configure a private hold key before you place the call on private hold.

To configure a private hold key via phone user interface:

1. Tap **Settings** from the Home screen.
2. Tap **DSS Keys** from the **Features** block.
3. Tap the desired line key.
4. Tap the **Type** field.
5. Tap **Key Event** in the pop-up dialog box.
6. Tap the **Key Type** field.
7. Tap **Private Hold** in the pop-up dialog box.

- (Optional.) Enter the string that will appear on the touch screen in the **Label** field.

- Tap to accept the change or to cancel.

Configuring Call Pull Feature

Call pull feature allows users to retrieve an existing call from another shared phone that is in active or public hold status.

To configure the call pull feature access code via web user interface:

- Click on **Account->Advanced**.
- Select the desired account from the pull-down list of **Account**.
- Enter the call pull feature access code (e.g., *11) in the **Call Pull Feature Access Code** field.

- Click **Confirm** to accept the change.

The phone will dial out “*11” automatically when you tap **CallPull**.

Using SCA Feature on the IP Phone

This section provides you with detailed information on using the CP960 IP phone in a SCA Hybrid Key System scenario. In a SCA Hybrid Key System scenario, the status of the line key icon

which associates with a shared line will change. For more information on line key icon, refer to [Icon Instructions](#) on page 15.

You can do the following using the IP phone in a SCA Hybrid Key System scenario:

- Place calls
- Answer calls
- Place a call on hold
- Retrieve a held call
- Barge in an active call
- Call Pull

Placing Calls

You can have one call or multiple calls on the shared line.

To place a call on the shared line:

Do one of following:

- Tap .
Enter the desired number using the onscreen dial pad.
Tap **Send**.
- Tap the line key from the DSS key screen to enter the dialing screen.
Enter the desired number using the onscreen dial pad and then tap **Send**.

To place multiple calls on the shared line:

You can have more than one call on the shared line. To place a new call when there is an active call on the line key 1 of phone A:

1. Tap **More->NewCall** to enter the dialing screen.
2. Enter the desired number using the onscreen dial pad.
3. Tap **Send**.
Phone A will dial the entered number using the line key 2 automatically.



Answering Calls

You can have one call or multiple calls on the shared line. Incoming calls will be distributed evenly among the available line keys.

To answer a call on the shared line:

When an incoming call arrives on the shared line, the phone A and phone B will ring simultaneously, and the icon indicators of the line key 1 on both phone A and phone B will become  and flash. You can answer the incoming call on either phone A or phone B but not both.

Do one of the following on phone A or phone B:

- Tap the line key 1 or tap **Answer** on phone A.
The icon indicators of the line key 1 on phone A and phone B will become  and stay solid.
- Tap the line key 1 or tap **Answer** on phone B.
The icon indicators of the line key 1 on phone A and phone B will become  and stay solid.

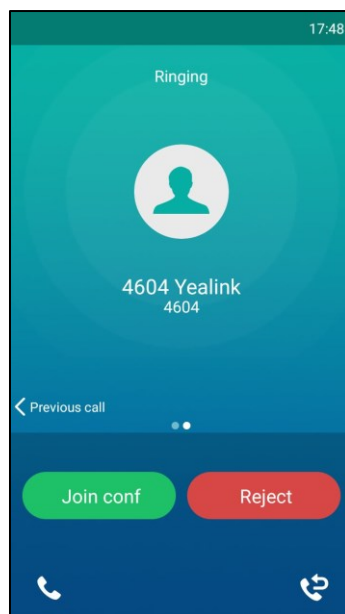

To answer multiple calls on the shared line:

An incoming call arrives on the shared line when there is an active call on phone A's line key 1. The icon indicators of the line key 2 on both phone A and phone B will become  and flash. You can answer the incoming call on either phone A or phone B. The touch screen of phone A displays the information of the incoming call.





Note Make sure call waiting feature is enabled on phone A. For more information, refer to [Call Waiting](#) on page 161.

On phone A:

1. Tap . Phone B stops ringing.
The incoming call is answered and the original call is placed on hold. The icon indicators of the line key 1 on phone A and phone B will become  and stay solid indicating that there is the held call on the line key 1. The icon indicators of the line key 2 on phone A and phone B will become  and stay solid indicating that there is an active call on the line key 2.

You can also answer the call on phone B. On phone B:

1. Tap . Phone B stops ringing.

The icon indicators of the line key 2 on phone A and phone B will become  and stay solid indicating that there is an active call on the line key 2. Meanwhile, the icon indicators of the line key 1 phone A and phone B will become  and stay solid indicating that there is the held call on the line key 1.

Note

If the number of incoming calls is greater than the configured line keys, the line keys will be used by sequence circulation.

Placing a Call on Hold

To place a call on public hold:

1. Tap **More->Hold** on phone A when party A and party C are talking.

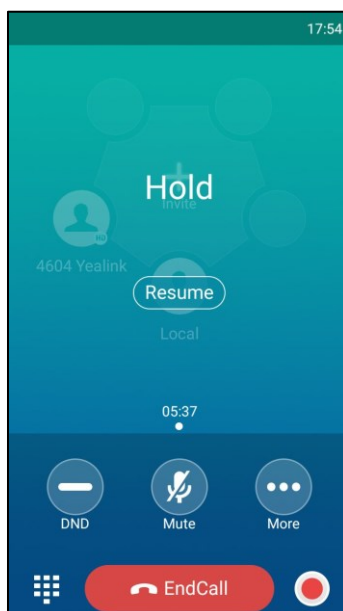



The icon indicators of line key 1 on phone A and phone B will become .

To place a call on private hold:

1. Tap **More->DSS Keys**.

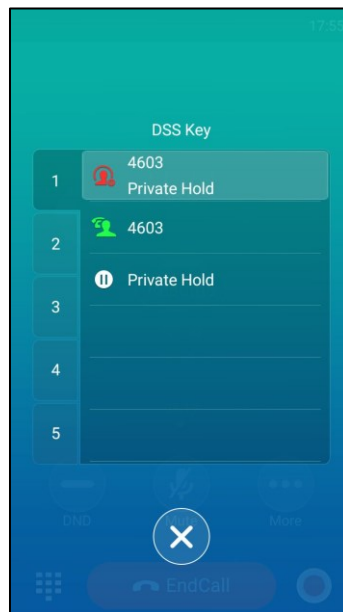
2. Tap private hold key on phone A when there is an active call on the shared line.



The icon indicators of line key 1 on phone A will become  when the shared line call is placed on private hold.

The icon indicators of line key 1 on phone B will become  when the shared line call is placed on private hold.

Retrieving a Held Call

To retrieve a call placed on public hold:

You can retrieve the public held call on either phone A or phone B.

To retrieve the call on phone A:

1. Tap , tap **Resume** or tap **More->Resume**.

The conversation between phone A and phone C is retrieved.

To retrieve the call on phone B:

Do one of the following:

- Tap .

- Long tap the desired line key.

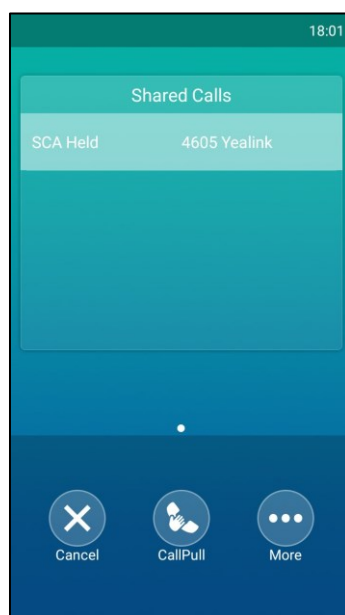

Tap **More**->**Retrieve** to retrieve the call.

The conversation is established between phone B and phone C, phone A disconnects the call. And the line key icon on phone A and phone B will become .

To retrieve a call placed on private hold:

The private held call can be only retrieved by the hold party (party A).

Do the following:

1. Tap , tap **Resume** or tap **More**->**Resume** on phone A.
The conversation between phone A and phone C is retrieved.

Barging In an Active Call

To interrupt the active call on the shared line:

If phone A has only one active call, do the following:

1. Long tap the desired line key on phone B.

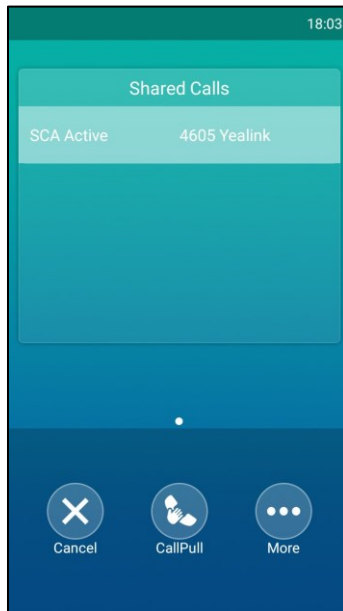

2. Tap **More->Barge In** to interrupt the active call of phone A.
Party B will set up a conference call with the other parties in the active call.
3. Tap **More->Hold** or **EndCall**.
 - If any party in the conference call taps **More->Hold**, two-way voice can be heard between the remaining parties.
 - If party A or party B taps **EndCall**, the remaining parties are still connected. If the other party (not the shared line party) taps **EndCall**, the conference call is ended.

Call Pull

Call pull feature allows users to retrieve an existing call from another shared phone that is in active or hold status. For example, when there is a call between phone A and phone C, you can use call pull feature on phone B to retrieve this call from phone A. Then the call is established between phone B and phone C.

To retrieve a call from another shared phone:

If there is an active call between phone A and phone C, do the following:

1. Long tap the desired line key on phone B.

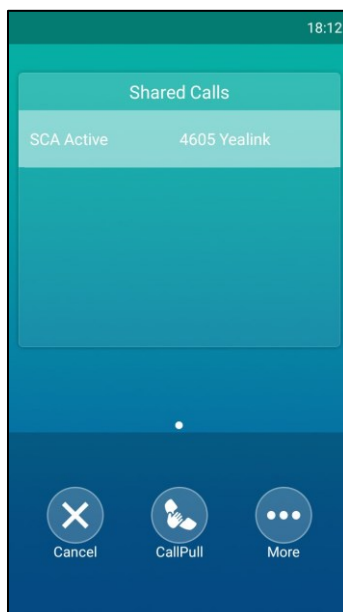

2. Tap **CallPull**.

The active call has been retrieved from the phone A successfully.

If there is a held call between phone A and phone C, do the following:

1. Long tap the desired line key on phone B.

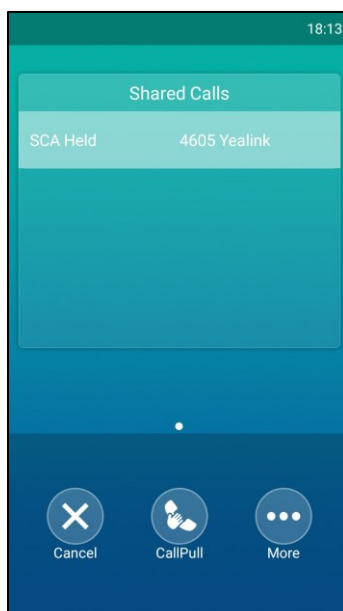

2. Tap **CallPull**.

The held call has been retrieved from the phone A successfully.

Message

Voice Mail

You can leave voice mails for someone else using the CP960 IP phone. You can also access the voice mails that are stored in the voice mailbox.

Note

Voice mail is not available on all servers and differs from different servers. Contact your system administrator for more information.

When receiving a new voice mail, the phone will play a warning tone. And the touch screen will prompt “n New Voice Mail(s)” (“n” indicates the number of unread voice mails, e.g., 42 New Voice Mail(s)) and display an icon .

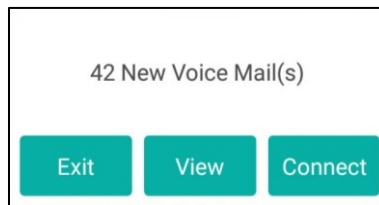

If the voice mail pop-up message box disappears, it won't pop up again unless the user receives a new voice mail or the user re-registers the account that has unread voice mail(s).

Note

You can configure the phone not to display the pop-up prompt, contact your system administrator for more information.

The icon  on the status bar has a counter indicating the number of messages you haven't heard yet.

Leaving Voice Mails

To leave a voice mail:

You can leave a voice mail for someone else when he/she is busy or inconvenient to answer the call. Follow the voice prompt from the system server to leave a voice mail, and then hang up.

Configuring the Voice Mail Access Codes

To configure voice mail access codes via phone user interface:

1. Tap  to launch **Message** application.
2. Tap **Set Voice Mail**.

3. Enter the voice mail access code (e.g., *88) in the desired account field.

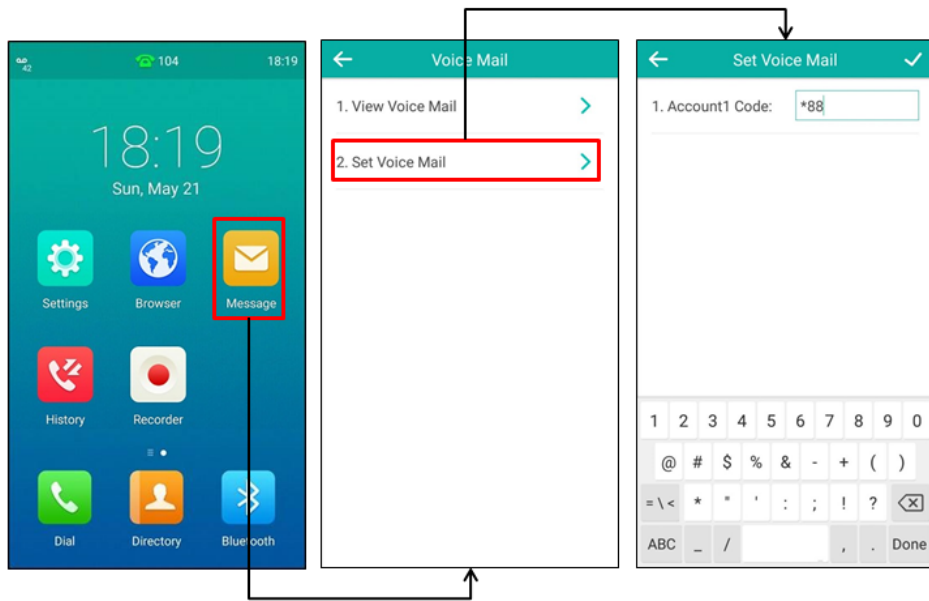

4. Tap ✓ to accept the change or ← to cancel.

Note Voice mail access codes must be predefined on the system server. Contact your system administrator for the more information.

Listening to Voice Mails

To listen to voice mails:

1. When the touch screen prompts that the phone receives a new voice mail, tap **Connect** to dial out the voice mail access code.
2. Follow the voice prompt to listen to your voice mails.

Note Before listening to voice mails, ensure that the voice mail access code has been configured. For more information, refer to [Configuring the Voice Mail Access Codes](#) on page 221.

To view the voice mail via phone user interface:

1. Tap  to launch **Message** application.
2. Tap **View Voice Mail**.

The touch screen displays the amount of new and old voice mails.

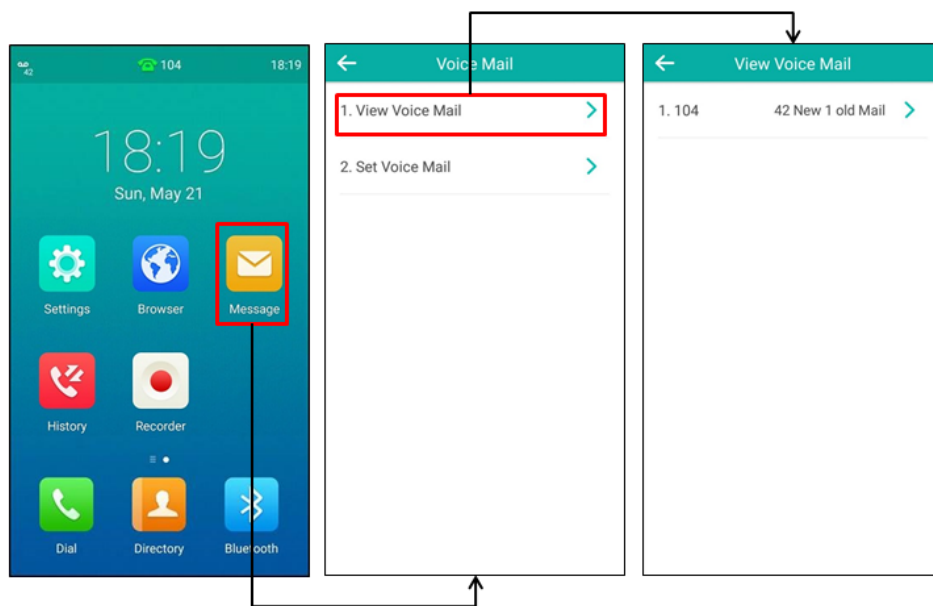

You can tap the account to listen to voice mails.

Message Waiting Indicator (MWI)

The CP960 IP phone supports MWI when receiving a new voice mail. If someone leaves you a voice mail, you will receive a message waiting indicator. MWI will be indicated in two ways: a warning tone and an indicator message (including a voice mail icon) on the touch screen. This will be cleared when you retrieve all voice mails or delete them.

The MWI service is unsolicited for some servers, so the CP960 IP phone only handles the MWI messages sent from the server. But for other servers, the MWI service is solicited, so the CP960 IP phone must enable subscription for MWI.

Note MWI service is not available on all servers. Contact your system administrator for more information.

The MWI subscription parameters you need to know:

Options	Description
Subscribe for MWI	Enable or disable a subscription for MWI service.
MWI Subscription Period	Period of MWI subscription. The IP phone sends a refresh SUBSCRIBE request before initial subscription expires.
Subscribe MWI To Voice Mail	Enable or disable a subscription to the voice mail number for MWI service. To use this feature, you should also configure the voice mail number.

Note

The phone will send SUBSCRIBE messages for MWI service to the account or the voice number MWI service depending on the server. Contact your system administrator for more information.

To configure subscribe for MWI via web user interface:

1. Click on **Account->Advanced**.
2. Select the desired account from the pull-down list of **Account**.
3. Select **Enabled** from the pull-down list of **Subscribe for MWI**.
4. Enter the period time in the **MWI Subscription Period(Seconds)** field.

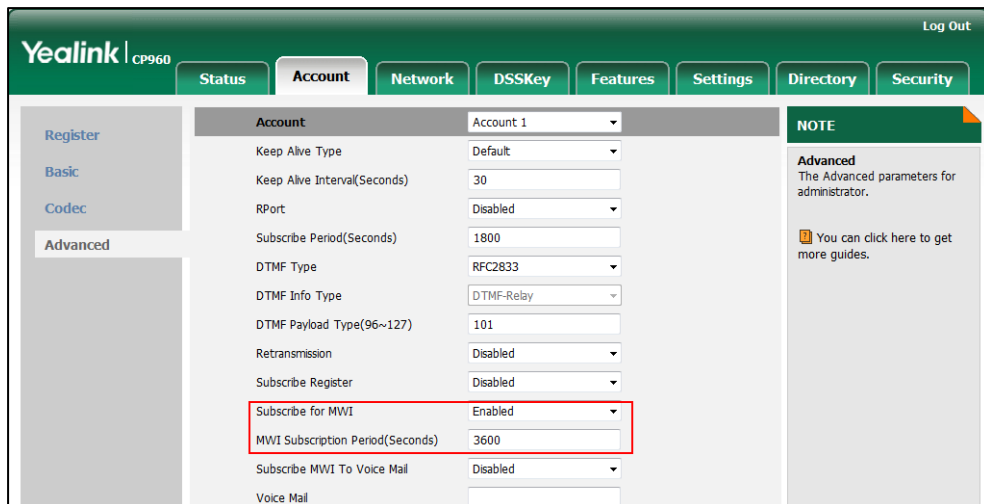

5. Click **Confirm** to accept the change.

The IP phone will subscribe to the account number for MWI service by default.

To enable subscribe MWI to voice mail via web user interface:

1. Click on **Account->Advanced**.
2. Select the desired account from the pull-down list of **Account**.
3. Select **Enabled** from the pull-down list of **Subscribe for MWI**.
4. Select **Enabled** from the pull-down list of **Subscribe MWI To Voice Mail**.

5. Enter the desired voice mail number in the **Voice Mail** field.

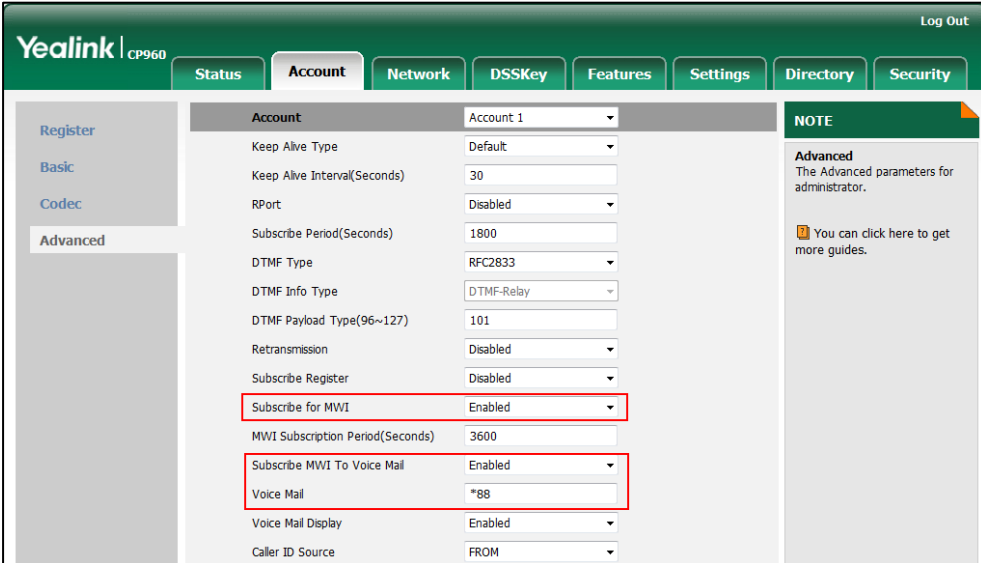

The screenshot shows the Yealink CP960 web interface. The 'Account' tab is selected, and the 'Advanced' sub-tab is active. The 'Voice Mail' field is highlighted with a red box and contains the value '*88'. Other fields highlighted with red boxes include 'Subscribe for MWI' (Enabled) and 'Subscribe MWI To Voice Mail' (Enabled). A 'NOTE' box on the right states: 'Advanced: The Advanced parameters for administrator. You can click here to get more guides.'

Parameter	Value
Account	Account 1
Keep Alive Type	Default
Keep Alive Interval(Seconds)	30
RPort	Disabled
Subscribe Period(Seconds)	1800
DTMF Type	RFC2833
DTMF Info Type	DTMF-Relay
DTMF Payload Type(96~127)	101
Retransmission	Disabled
Subscribe Register	Disabled
Subscribe for MWI	Enabled
MWI Subscription Period(Seconds)	3600
Subscribe MWI To Voice Mail	Enabled
Voice Mail	*88
Voice Mail Display	Enabled
Caller ID Source	FROM

6. Click **Confirm** to accept the change.

The IP phone will subscribe to the voice mail number for MWI service using Subscribe MWI To Voice Mail.

Note

MWI subscription is configurable via web user interface only.

Connecting Bluetooth Devices and PC

Connecting a Mobile Phone Using Bluetooth

The CP960 IP phone supports Bluetooth. Bluetooth enables low-bandwidth wireless connections within a range of 10 meters (32 feet). The best performance is in the 1 to 2 meters (3 to 6 feet) range.

You can pair and connect the Bluetooth-Enabled mobile phone with your IP phone. After connection, you can do the following:

- Make and receive mobile calls on the IP phone (refer to [Placing a Mobile Call over Bluetooth](#)).
- Use the IP phone as a Bluetooth speaker for music played on your mobile phone.
- Merge the calls on you IP phone, the PC and connected mobile phone into to a hybrid UC conference (refer to [Creating a Hybrid UC Conference](#)).

Note

Not all mobile phones support this function. Contact your system administrator for more information.

You can also connect a PC (operation system: macOS and Windows 10) via Bluetooth. After connection, you can place/answer a call via a softphone installed on PC using the IP phone.

Activating/Deactivating the Bluetooth Mode

To activate the Bluetooth mode via phone user interface:

1. Do one of the following:

- Tap .
- Swipe down from the top of the screen to enter the control center.
Long tap **Bluetooth**.
- Tap **Settings** from the Home screen.
Tap **Bluetooth** from the **Basic** block.

2. Turn on **Bluetooth**.

The IP phone scans the available Bluetooth device automatically. After scanning, the touch screen displays the Bluetooth device information (device type and device name).

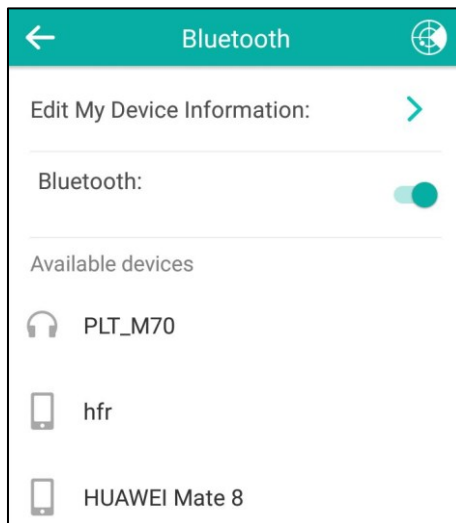

The touch screen displays the Bluetooth icon.

To deactivate the Bluetooth mode via phone user interface:

1. Do one of the following:

- Tap .
- Swipe down from the top of the screen to enter the control center.
Long tap **Bluetooth**.
- Tap **Settings** from the Home screen.
Tap **Bluetooth** from the **Basic** block.

2. Turn off **Bluetooth**.

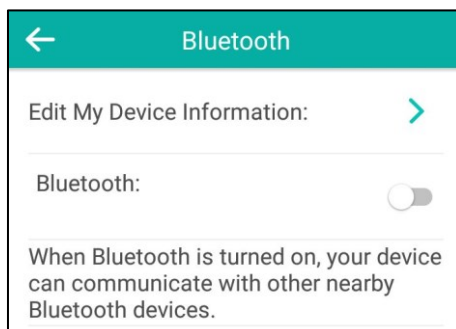

The Bluetooth icon disappears from the status bar.

Bluetooth mode is configurable via web user interface at the path **Features->Bluetooth**.

Pairing and Connecting the Bluetooth-Enabled Mobile Phone

You can pair up to countless mobile phones with your IP phone; however, only one mobile phone can be connected at a time. After connection, the IP phone will automatically find an available line key and assign the line key for Mobile Account. The Mobile Account key's default label is "My Mobile". If there is no available line key, you may assign it manually.

Before you pair a mobile phone, check the Bluetooth mode on the mobile phone to make sure that the mobile phone is discoverable.

To pair and connect the Bluetooth-Enabled Mobile Phone with your IP phone:

1. Activate the Bluetooth mode.

If there is no mobile phone found on the touch screen, tap  to search for the mobile phone.

2. Tap the desired mobile phone in the Bluetooth devices list to connect the mobile phone to your IP phone.
3. Tap **Pair** on both mobile phone and IP phone.

Once the connection has completed successfully, the prompt "Connected" appears under the mobile phone name.

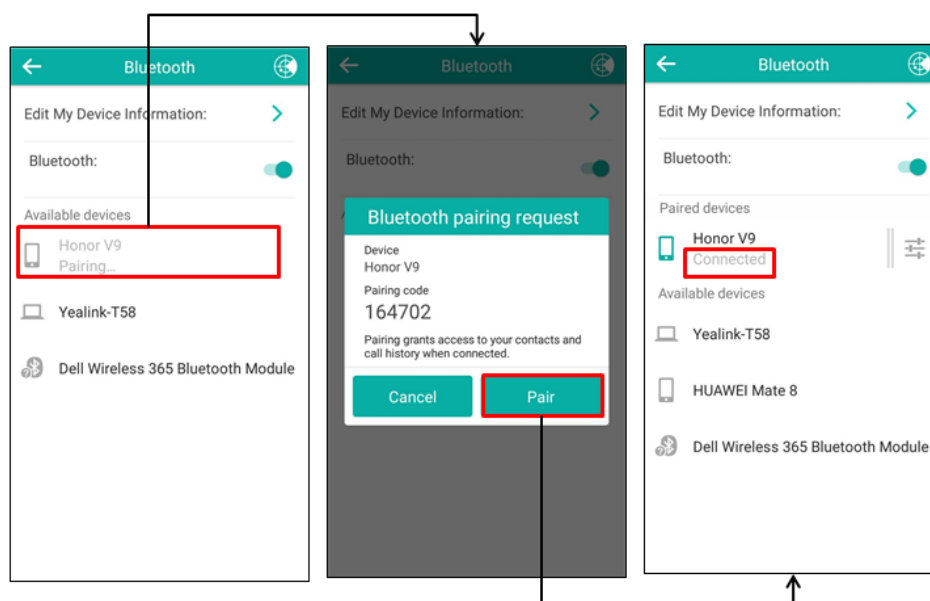

The Bluetooth icon  will display on the status bar. And the IP phone automatically assigns a Mobile Account key.

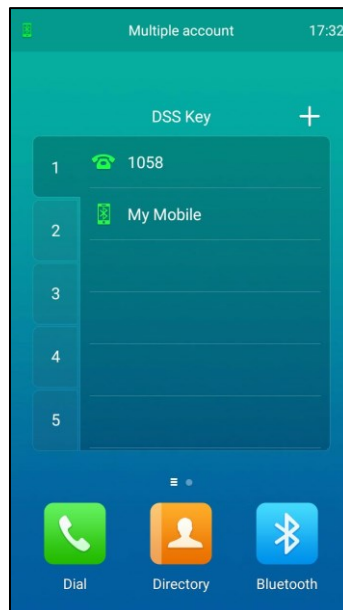

For more information on how to configure the Mobile Account key, refer to [Mobile Account](#) on page 113. Before you configure the Mobile Account key, make sure the mobile phone is connected. Otherwise the IP phone will prompt "Mobile Account is not connected!".

Making/Receiving a Mobile Call on the IP Phone

You can enable the phone audio feature to make/receive a mobile call using the IP phone. Then the IP phone acts as a hands free device for your mobile phone. The call is made through your mobile phone, but the audio is present on and the call control is done by the IP phone.

For more information on how to make/receive a mobile call on the IP phone, refer to [Placing a Mobile Call over Bluetooth](#) on page 140 and [Answering Calls](#) on page 142.

To configure the phone audio feature:

1. Pair and connect the Bluetooth-Enabled mobile phone.
2. Tap  after the connected mobile phone name.

3. Turn on **Phone audio**.

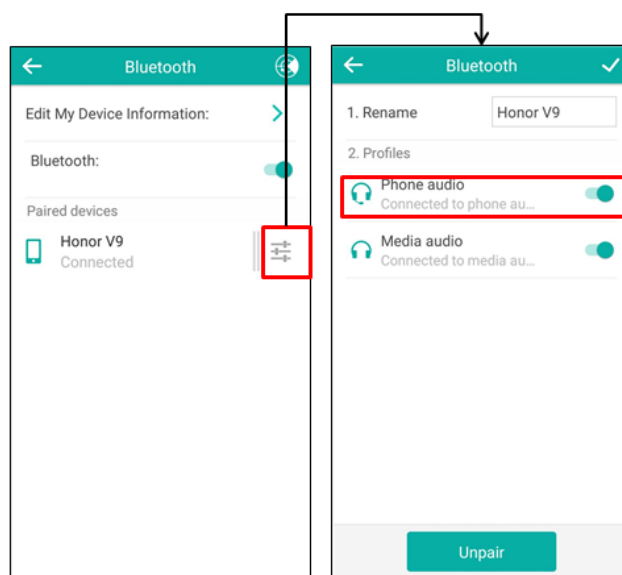

4. Tap ✓ to accept the change or ← to cancel.

Using Your IP Phone as Bluetooth Speaker

You can enable the media audio feature to use the IP phone as a Bluetooth speaker for music played on your mobile phone.

To configure the media audio feature:

1. Pair and connect the Bluetooth-Enabled mobile phone.
2. Tap  after the connected mobile phone name.
3. Tap the switch button in **Media audio** field.

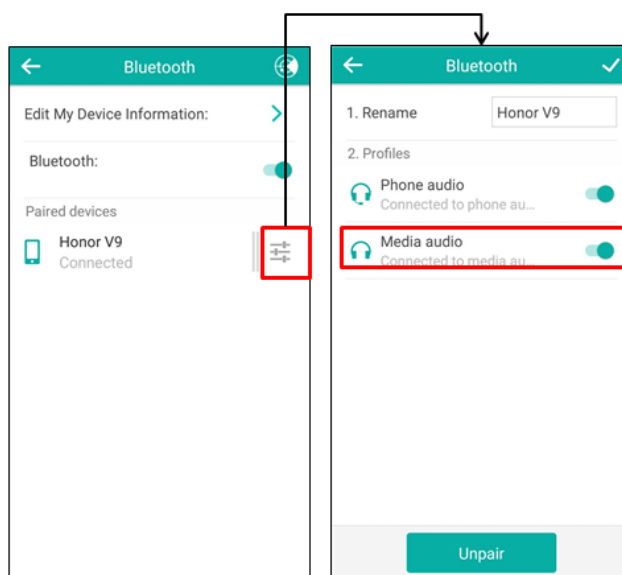

4. Tap ✓ to accept the change or ← to cancel.

Renaming the Paired Bluetooth Device

To rename the paired Bluetooth device:

1. Pair and connect the Bluetooth-Enabled mobile phone.
2. Tap ⓘ after the connected mobile phone name.
3. Enter the desired device name in the **Rename** field.

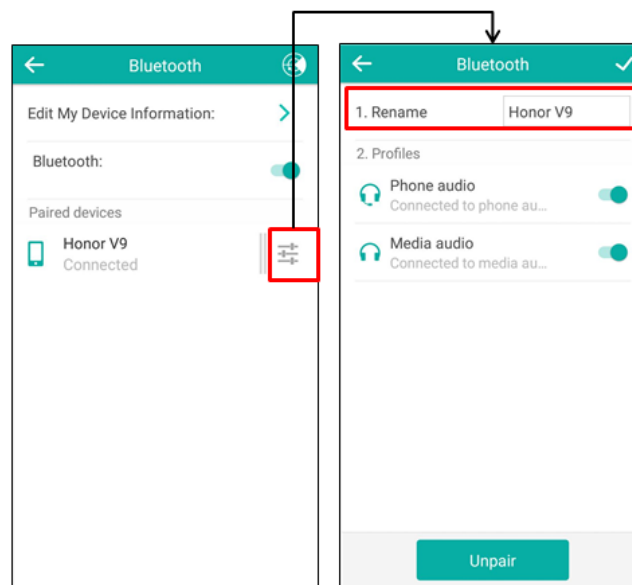

4. Tap ✓ to accept the change or ← to cancel.

The configured mobile phone name will display in the **PAIRED DEVICES** list on your IP phone. The mobile phone name displayed in scanning list of other devices will not be changed.

Note The icon ⓘ only appears after the device name of the Bluetooth device that you are connecting or have connected.

Making the IP Phone Discoverable



If you make your IP phone visible to other Bluetooth devices, other Bluetooth devices can scan and find your IP phone. But if not, your IP phone' device name will not display in scanning list of other devices.

To make the IP phone discoverable:

1. Activate the Bluetooth mode.
2. Tap **Edit My Device Information**.

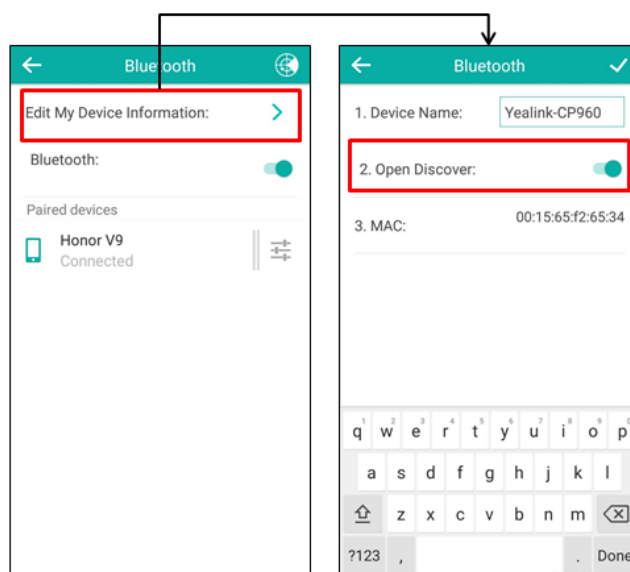
3. Turn on **Open Discover**.



4. Tap  to accept the change or  to cancel.

The IP phone will be visible to all Bluetooth devices nearby.



Editing Device Information

To edit device information via phone user interface:

1. Activate the Bluetooth mode.
2. Tap **Edit My Device Information**.
3. Enter the desired name in the **Device Name** field.

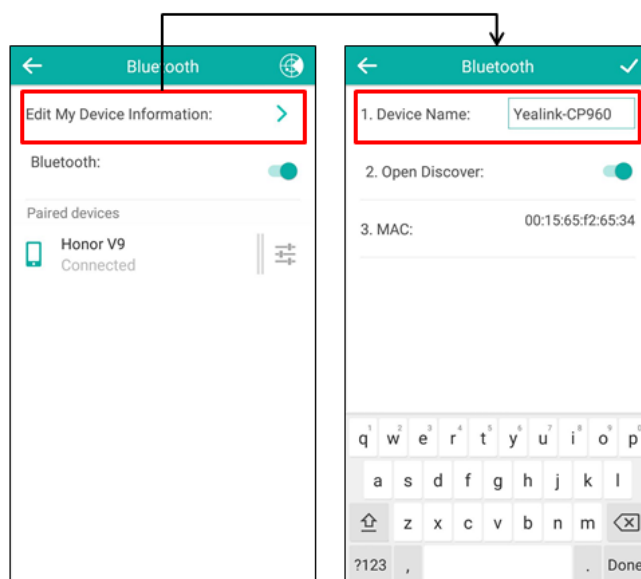
The default device name is "Yealink-CP960".



4. Tap  to accept the change or  to cancel.

You should make your IP phone discoverable first, and then the pre-configured Bluetooth device name will display in scanning list of other device.

Disconnecting the Bluetooth Device

To disconnect your Bluetooth device from your IP phone:

- Do one of the following:
 - Tap .
 - Swipe down from the top of the screen to enter the control center. Long tap **Bluetooth**.
 - Tap **Settings** from the Home screen. Tap **Bluetooth** from the **Basic** block.
- Tap the connected mobile phone.

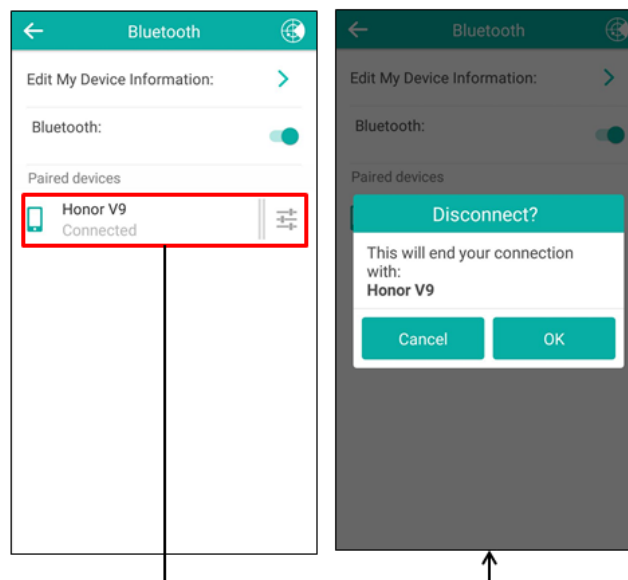

3. Tap **OK** to accept the change or **Cancel** to cancel.

The mobile phone is disconnected. To connect it to your IP phone again, tap the mobile phone again.

Unpairing the Mobile Phone

You can unpair your mobile phone with your IP phone. When you unpair the mobile phone, the mobile phone information disappears from the **PAIRED DEVICES** list. To connect the mobile phone to your IP phone again, tap the desired mobile phone in the **AVAILABLE DEVICES** list.

To unpair Bluetooth device via phone user interface:

1. Do one of the following:
 - Tap .
 - Swipe down from the top of the screen to enter the control center. Long tap **Bluetooth**.
 - Tap **Settings** from the Home screen. Tap **Bluetooth** from the **Basic** block.

The touch screen displays the paired and connected Bluetooth device.

2. Tap  after the connected mobile phone name.
3. Tap **Unpair**.

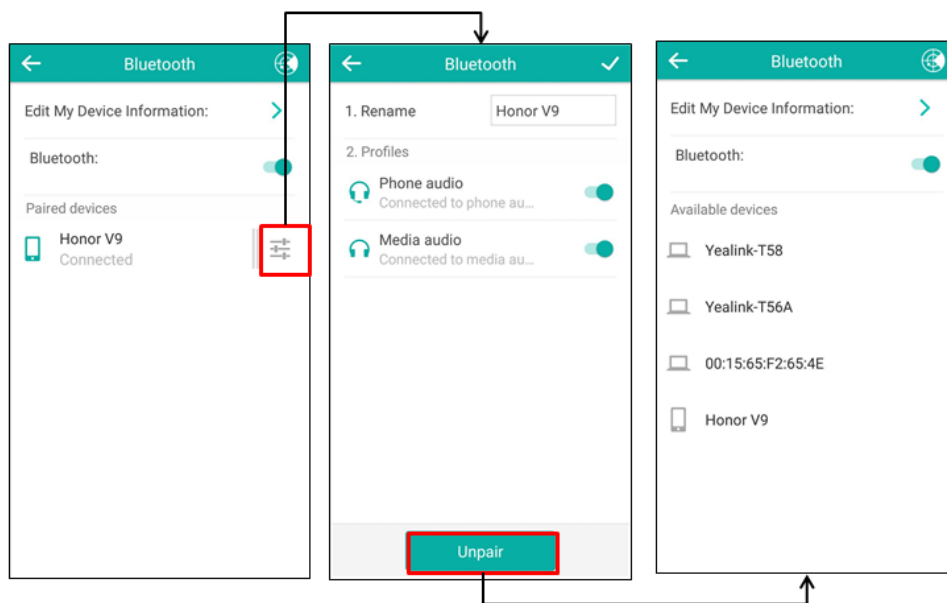

The mobile phone disappears from the **PAIRED DEVICES** list.

Connecting a PC Using a USB Cable

You can connect a PC to your IP phone so you can use it as a speaker for calls or media played on your PC. For more information on how to connect the PC, refer to [Connect the Optional PC](#) on page 28.

From your IP phone, you can do the following:

- Manage the PC audio. The PC audio is the audio from calls or media played on your PC.
- Merge the calls on you IP phone, the PC and connected mobile phone into to a hybrid UC conference. For more information, refer to [Creating a Hybrid UC Conference](#) on page 166.
- Answer calls from other IP phones.

Note

You can install .a softphone (e.g., Yealink VC Desktop) on PC to make IP calls.

Connecting the PC Audio

You can connect the PC when your IP phone is idle, when you have a call or conference call, or when you are placing a call.

After connection, you can use the IP phone to play audio from calls, and from media including music and videos.

To connect the PC audio when your IP phone is idle:

1. Connect the PC to the IP phone.

The PC audio plays through your IP phone's speaker.

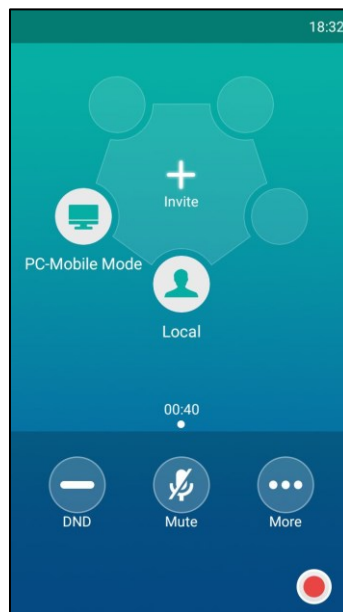

To connect the PC audio when there is a call or conference call on your IP phone:

1. Connect the PC to the IP phone.

The original call or conference call is placed on hold. The PC audio plays through your IP phone's speaker.

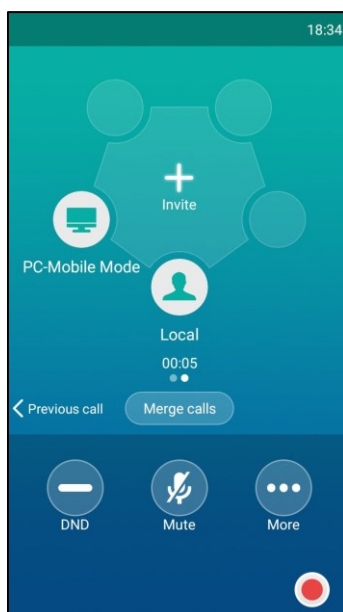

To connect the PC audio when you are placing a call:

1. Connect the PC to the IP phone.

The dialing is canceled. The PC audio plays through your conference phone's speaker.

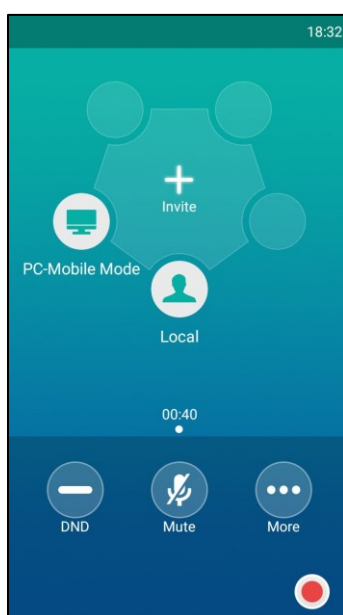

Managing the PC Audio

After connecting the PC to the IP phone, you can do the following:

- Place an active PC audio on hold.
- Mute or unmute the microphone.

- Adjust the volume of the PC audio.

Placing the PC Audio on Hold

When you place the PC audio on hold, you cannot hear any audio associated with the PC on your IP phone.

To place the PC audio on hold:

1. Tap **More->Hold**.

The touch screen indicates that the audio is on hold.

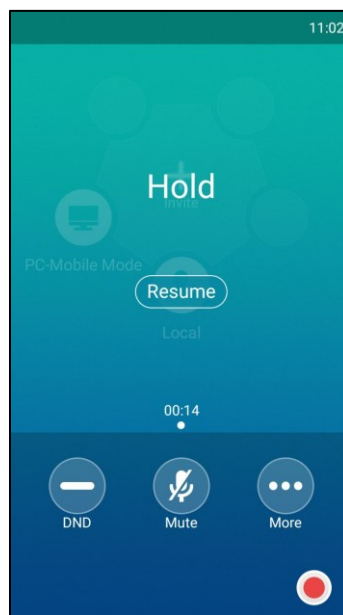

To resume the PC audio, do one of the following:

- Tap **Resume**.
- Tap **More->Resume**.

Muting or Unmuting the Microphone

The following occurs when you mute the microphone:

- The other party cannot hear you but you can still hear all other parties.
- You cannot record your voice on PC.

To mute the microphone, do one of the following:

- Tap **Mute**.
- Tap the Mute touch key.

Mute key LED indicators illuminate solid red. The touch screen indicates that the audio is muted.

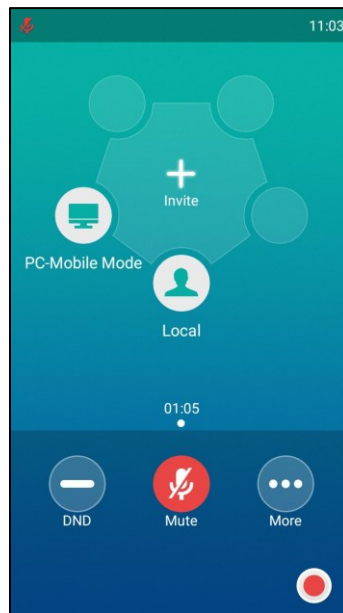

To unmute the microphone, do one of the following:

- Tap **Mute** again.
- Tap the Mute touch key again.

Adjusting the Volume of the PC Audio

To adjust the volume of the PC audio:

1. When you connect the PC audio, tap one of the Volume touch key to increase or decrease the volume of the IP phone's speaker.

Setting the IP Phone as PC Audio Device



If you connect a PC to the IP phone, the PC will use the IP phone to play audio from calls or media by default. If not, you can set the IP phone as PC audio device. You can set the IP phone as PC audio device via softphone or PC.

Setting the IP Phone as PC Audio Device via Softphone

When your PC is connected to the IP phone, you can set the IP phone as PC audio input and output device via the softphone. Then you can play audio from the calls using the IP phone speakers and use the IP phone as your microphone.

The following takes setting the IP phone as PC audio input and output device via Yealink VC Desktop as example. If you do not have the Yealink VC Desktop application, download the application from the [Yealink VC Desktop Support](#) page.

To set the IP phone as PC audio device via the Yealink VC Desktop:

1. Click  -> **Device**.
2. Select **扬声器(SIP-CP960)** from the pull-down list of **Speaker**.
3. Select **麦克风(SIP-CP960)** from the pull-down list of **Microphone**.
4. Click  to test the volume.

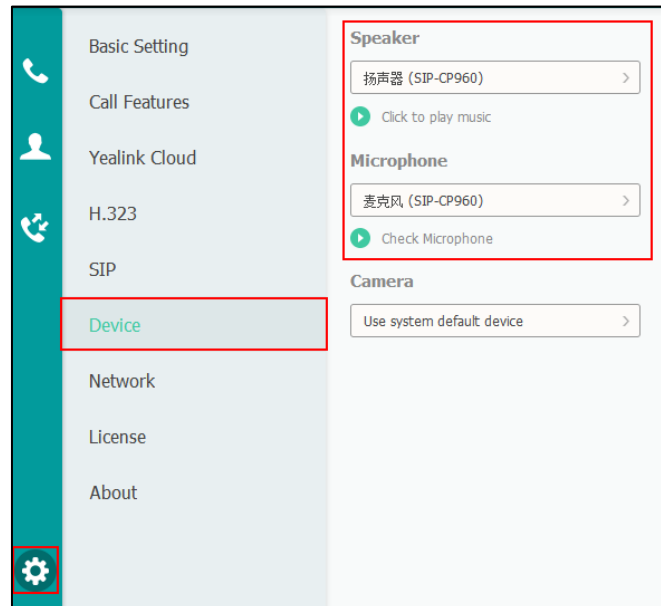

5. Click **Save changes**.

Settings the IP Phone as PC Audio Device via PC

When your PC is connected to the IP phone, you can set the IP phone as the default audio device for your PC and play audio from music and videos using the IP phone's speakers.

To set the IP phone as PC audio input device via PC:

1. Click **Start->Control Panel->Sound**.
2. Click **SIP-CP960** and click **Set Default**.
3. Click **OK**.

Removing the PC Audio

To remove the PC audio, disconnect the USB cable from the IP phone.

Using the CP Wireless Expansion Mic CPW90

This chapter provides basic operating instructions for the wireless expansion microphone CPW90. Topics include:

- [Placing the CPW90](#)
- [Turning the CPW90](#)
- [Registering/Unregistering the CPW90](#)
- [Muting or Unmuting the CPW90](#)
- [Idle Mode](#)
- [Viewing CPW90 Information](#)
- [Finding the CPW90](#)
- [Charging the CPW90](#)
- [CPW90 LED Instructions](#)
- [CPW90 Working Frequency](#)

If you require additional information or assistance with the CPW90, contact your system administrator.

Placing the CPW90

The CPW90 has a rubber pads on its base to prevent it from sliding. You can place the CPW90 on a conference table. Do the following to ensure optimal voice quality:

- The CPW90 should be less than 20 meters distant from the IP phone, and is not disturbed by obstacles.
- Place the CPW90 on a stable surface and keep it away from obstacles so that it can effectively pick up sounds.

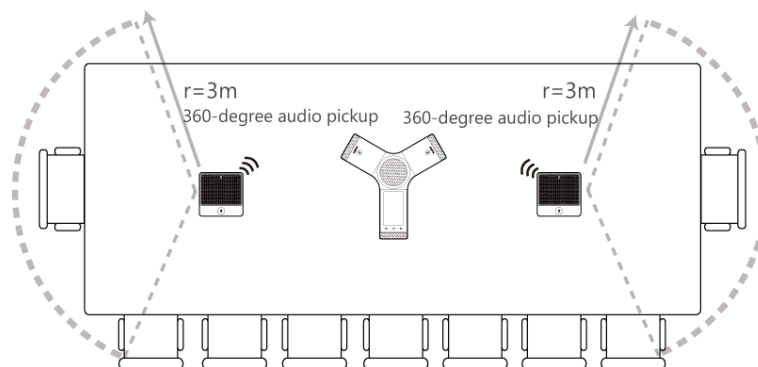

Turning the CPW90 On or Off

To turn on the CPW90, do the following:

- Put the CPW90 on a charging cradle, the CPW90 starts up automatically.
- If you do not charge the CPW90, long tap  on the CPW90 for 3 seconds.

The battery indicator LED illuminates solid green for one second and then goes out.

To turn off the CPW90:

1. Long tap  on the CPW90 until the battery indicator LED on the CPW90 illuminates solid red for 3 seconds and then goes out.

Registering/Unregistering the CPW90

The Yealink CPW90 is a CP Wireless Expansion Mic which works as an audio input device for CP960 IP phone. It features superior audio technology and supports 360-degree voice pickup range at a radius of up to 10 feet (3 meters) without any wiring troubles.

To ensure good voice quality of the calls on the IP phone, you can register CPW90 with the IP phone to use the CPW90 as the external audio input device.

Note

If you buy CP960-WirelessMic, the CPW90 is registered with the IP phone by default.

CPW90 can only be registered with one IP phone at a time, if you register the CPW90 to another IP phone, the CPW90 will deregister from the previous IP phone automatically.

To register the CPW90 with the IP phone:

1. Do the following on the IP phone:
 - Tap **Settings** from Home screen.
 - Tap **Wireless Microphone** from **Basic** block.

Tap  to search for CPW90.

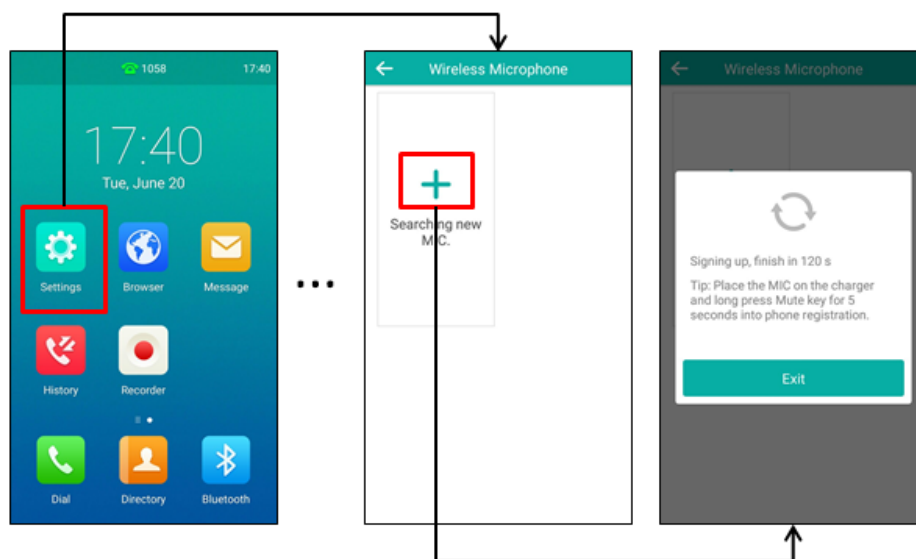

2. Turn on the CPW90.

The CPW90 will enter the registration mode automatically. And the mute indicator LED on the CPW90 fast flashes yellow.

The CPW90 registers with the IP phone automatically. If the registration is successful, the mute indicator LED on the CPW90 goes out and the touch screen of IP phone prompts the CPW90 information: battery, work time and standby time.

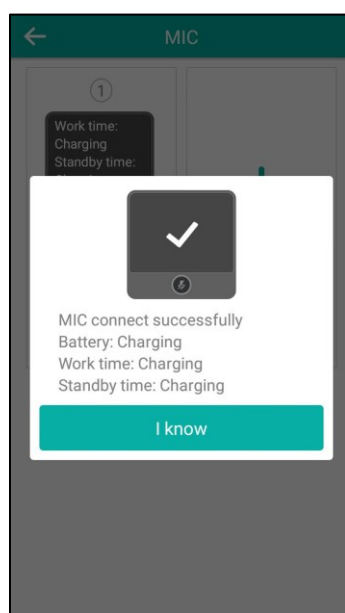

To register the CPW90 with another IP phone:

- Do the following on the IP phone:
 - Tap **Settings** from Home screen.
 - Tap **Wireless Microphone** from **Basic** block.

Tap  to search for CPW90.

2. Put the CPW90 on the charging cradle and make sure it is charging.
3. Long tap  on the CPW90 for 5 seconds.

The CPW90 enters the registration mode. And the mute indicator LED on the CPW90 fast flashes yellow.

The CPW90 registers with the IP phone automatically.

To deregister the CPW90 from the IP phone:

1. Tap **Settings** from Home screen.
2. Tap **Wireless Microphone** from **Basic** block.
3. Select the desired microphone and then tap **Detail**.
4. Tap **Unbind** to deregister the CPW90.

Muting or Unmuting the CPW90

To mute the CPW90 during a call:

1. Tap  to mute the call.

The mute indicator LED illuminates solid red. And the icon  appears on the status bar of the IP phone.

To unmute the CPW90 during a call:

1. Tap  again to unmute the call.

The mute indicator LED illuminates solid green. And the icon  disappears from the status bar of the IP phone.

Idle Mode

When the CPW90 registers with the IP phone successfully, the CPW90 enters the idle mode. You can tap  on the CPW90, the battery indicator LED on the CPW90 illuminates solid green for 3 seconds and then goes out.

Viewing CPW90 Information

When the CPW90 is registered with the IP phone, you can view CPW90 status on the IP phone.

Available information of CPW90 includes:

- Register Status
- Mic Model
- MICPOD IPEI
- Battery Percent

- Standby Time (estimated standby time)
- Work Time(estimated working time)

To view the CPW90 information on the IP phone:

1. Tap **Settings** from Home screen.
2. Tap **Wireless Microphone** from **Basic** block.
3. Tap **Detail** from the desired microphone block.

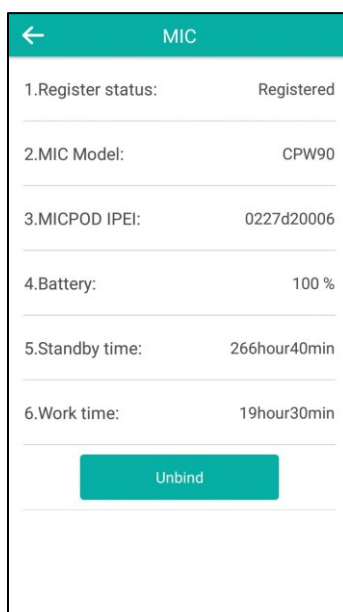

Finding the CPW90

You can find the CPW90 which has registered with the IP phone.

To find the registered CPW90:

1. Tap **Settings** from Home screen.
2. Tap **Wireless Microphone** from **Basic** block.
3. Tap **Find** from the desired microphone block.

The mute indicator LED on the registered CPW90 flashes red and green alternately.

Charging the CPW90

To charge the CPW90:

1. Put the CPW90 on the charging cradle.

2. Connect the micro USB port on the charging cradle to the USB port on the IP phone using a 0.3m micro USB cable.

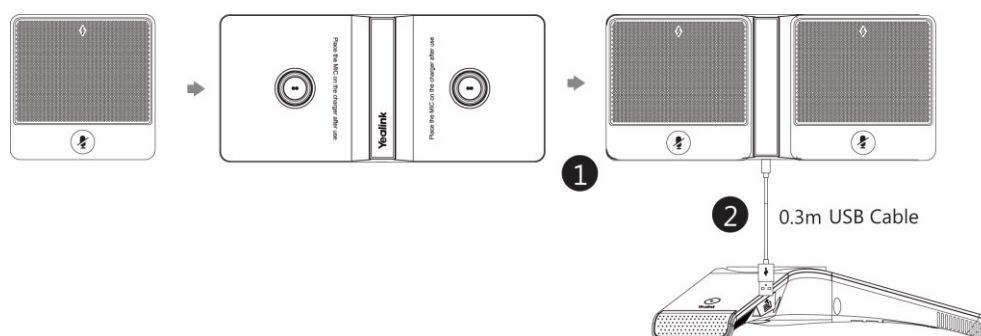

During charging, the battery LED indicator on the CPW90 illuminates solid red. When the battery capacity reaches 100%, the battery LED indicator on the CPW90 will illuminate solid green.

Note

If it is the first time you use the CPW90, you need to fully charge the CPW90 for normal use.
If the CPW90 is not in use, we recommend you to charge the CPW90 even when the battery is full.

CPW90 LED Instructions

Mute button indicator LED on the wireless expansion microphone CPW90:

LED Status	Description
Solid green	The phone enters the pre-dialing screen. The phone is in a call an unmuted.
Slowly flashing red	The phone is receiving an incoming call.
Solid red	The phone is muted.
Fast flashing yellow	The CPW90 is in the registration mode.
Slowly flashing yellow	The CPW90 has registered with the phone, but the CPW90 is out of range. The CPW90 has registered with the phone, but the CP960 is turned off.
Flashing red and green alternately	The phone is searching for the CPW90 which has registered with it.
Off	The CPW90 is in the idle mode.

Battery indicator LED on the wireless expansion microphone CPW90:

LED Status	Description
Solid green for one second and then off	The CPW90 is turned on.
Solid green for 3 seconds and then off	The CPW90 is in the idle mode.

LED Status	Description
Solid green	The CPW90 is fully charged.
Solid red	The CPW90 is being charged.
Fast flashing red 3 times and then off	The battery capacity is too low to turn on the CPW90.
Slowly flashing red	The battery capacity is less than 10%.
Off	If you tap the mute button, the battery indicator LED on the CPW90 is still off, it means the CPW90 is turned off.

CPW90 Working Frequency

For reference, the Frequency/Channels of CPW90 used in each Region are tabulated below:

Freq (MHz)	RF Carrier Index (DECT tester Numbering)						
	EU	Taiwan	US	LA	Korea	Brazil	Japan
1881.792	9	9					
1883.520	8	8					
1885.248	7	7					
1886.976	6	6					
1888.704	5	5					
1890.432	4	4					
1892.160	3	3					
1893.888	2	2					
1895.616	1						4(F1)
1897.344	0						3(F2)
1899.072							2(F3)
1900.800							1(F4)
1902.528							0(F5)
1904.256							
1905.984							
1907.712							
1909.440							
1911.168						4	
1912.896				9		3	

Freq (MHz)	RF Carrier Index (DECT tester Numbering)						
	EU	Taiwan	US	LA	Korea	Brazil	Japan
1914.624				8		2	
1916.352				7		1	
1918.080				6		0	
1919.808				5			
1921.536			4	4			
1923.264			3	3			
1924.992			2	2			
1926.720			1	1			
1928.448			0	0			
1787.616					8		
1789.344					7		
1791.072					6		

Appendix A - Time Zones

Time Zone	Time Zone Name
-11	Samoa
-10	United States-Hawaii-Aleutian, United States-Alaska-Aleutian
-9:30	French Polynesia
-9	United States-Alaska Time
-8	Canada(Vancouver,Whitehorse), Mexico(Tijuana,Mexicali), United States-Pacific Time
-7	Canada(Edmonton,Calgary), Mexico(Mazatlan,Chihuahua), United States-MST no DST, United States-Mountain Time
-6	Canada-Manitoba(Winnipeg), Chile(Easter Islands), Mexico(Mexico City,Acapulco), United States-Central Time
-5	Bahamas(Nassau), Canada(Montreal,Ottawa,Quebec), Cuba(Havana), United States-Eastern Time
-4:30	Venezuela(Caracas)
-4	Canada(Halifax,Saint John), Chile(Santiago), Paraguay(Asuncion), United Kingdom-Bermuda(Bermuda), United Kingdom(Falkland Islands), Trinidad&Tobago
-3:30	Canada-New Foundland(St.Johns)
-3	Argentina(Buenos Aires), Brazil(DST), Brazil(no DST), Denmark-Greenland(Nuuk)
-2:30	Newfoundland and Labrador
-2	Brazil(no DST)
-1	Portugal(Azores)
0	Denmark-Faroe Islands(Torshavn), GMT, Greenland, Ireland(Dublin), Morocco, Portugal(Lisboa,Porto,Funchal), Spain-Canary Islands(Las Palmas), United Kingdom(London)
+1	Albania(Tirane), Austria(Vienna), Belgium(Brussels), Caicos, Chad, Croatia(Zagreb), Czech Republic(Prague), Denmark(Kopenhagen), France(Paris), Germany(Berlin), Hungary(Budapest), Italy(Rome), Luxembourg(Luxembourg), Macedonia(Skopje), Namibia(Windhoek), Netherlands(Amsterdam), Spain(Madrid)
+2	Estonia(Tallinn), Finland(Helsinki), Gaza Strip(Gaza), Greece(Athens), Israel(Tel Aviv), Jordan(Amman), Latvia(Riga), Lebanon(Beirut), Moldova(Kishinev), Romania(Bucharest), Russia(Kaliningrad), Syria(Damascus), Turkey(Ankara), Ukraine(Kyiv, Odessa)
+3	East Africa Time, Iraq(Baghdad), Russia(Moscow)
+3:30	Iran(Teheran)
+4	Armenia(Yerevan), Azerbaijan(Baku), Georgia(Tbilisi), Kazakhstan(Aktau), Russia(Samara)
+4:30	Afghanistan(Kabul)
+5	Kazakhstan(Aqtobe), Kyrgyzstan(Bishkek), Pakistan(Islamabad), Russia(Chelyabinsk)
+5:30	India(Calcutta)
+5:45	Nepal(Katmandu)
+6	Kazakhstan(Astana, Almaty), Russia(Novosibirsk,Omsk)
+6:30	Myanmar(Naypyitaw)
+7	Russia(Krasnoyarsk), Thailand(Bangkok)
+8	Australia(Perth), China(Beijing), Russia(Irkutsk, Ulan-Ude), Singapore(Singapore)
+8:45	Eucla
+9	Japan(Tokyo), Korea(Seoul), Russia(Yakutsk,Chita)
+9:30	Australia(Adelaide), Australia(Darwin)

Time Zone	Time Zone Name
+10	Australia(Brisbane), Australia(Hobart), Australia(Sydney,Melboume,Canberra), Russia(Vladivostok)
+10:30	Australia(Lord Howe Islands)
+11	New Caledonia(Noumea), Russia(Srednekolymk Time)
+11:30	Norfolk Island
+12	New Zealand(Wellington,Auckland), Russia(Kamchatka Time)
+12:45	New Zealand(Chatham Islands)
+13	Tonga(Nukualofa)
+13:30	Chatham Islands
+14	Kiribati

Index

A

About This Guide [v](#)
 Account Management [113](#)
 Account Registration [113](#)
 Activating/Deactivating the Bluetooth Mode [226](#)
 Adding a Contact to the Blacklist [100](#)
 Adding Contacts [86](#)
 Adding Groups [83](#)
 Administrator Password [70](#)
 Adjusting the Volume of the PC Audio [238](#)
 Advanced Phone Features [180](#)
 Anonymous Call [175](#)
 Anonymous Call Rejection [176](#)
 Answering Calls [140](#)
 Answering Calls Automatically [142](#)
 Answering When in Another Call [142](#)
 Answering When Not in Another Call [142](#)
 Area Code [119](#)
 Appendix A - Time Zones [249](#)
 Assigning Functionality to a Line Key [105](#)
 Attended Transfer [161](#)
 Audio Settings [75](#)
 Auto Redial [152](#)

B

Backlight [64](#)
 Barging In an Active Call [219](#)
 Basic Network Settings [46](#)
 Basic Phone Features [138](#)
 Blacklist [95](#)
 BLF List [186](#)
 Blind Transfer [159](#)
 Block Out [120](#)
 Browser [129](#)
 Browsing a Web Page [130](#)
 Busy Lamp Field (BLF) [180](#)

C

Call and Conference Recording (Local) [188](#)
 Call Completion [153](#)
 Call Mute/Unmute [155](#)
 Call History Management [99](#)
 Call Hold/Resume [157](#)
 Call Park [169](#)
 Call Pickup [171](#)
 Call Recording [188](#)
 Call Recording (Server Side) [191](#)
 Call Transfer [159](#)
 Call Waiting [161](#)
 Calls Screen [34](#)
 Charging the CPW90 [245](#)
 Checking Storage Space [129](#)
 Clearing the Navigation History [134](#)

Clock [135](#)
 Conference [162](#)
 Configuration Screen [35](#)
 Configuring an Access URL [97](#)
 Configuring the BLF Feature on the Phone [180](#)
 Configuring the Intercom Feature on the Phone [195](#)
 Configuring SCA Feature on the IP Phone [208](#)
 Connect the Optional External Speaker [29](#)
 Connect the Optional PC [28](#)
 Connect the Optional USB Flash Drive [29](#)
 Connect the Power and Wired Network [28](#)
 Connecting a Device Using a USB Cable [234](#)
 Connecting a Device Using Bluetooth [226](#)
 Connecting Bluetooth Devices and PC [226](#)
 Connecting to the Wireless Network [49](#)
 Connecting the PC in Different Status [234](#)
 Contact Management [82](#)
 Control Center/Notification Center [33](#)
 Copying Recorded Audios to USB Flash Drive [126](#)
 CPW90 LED Instructions [246](#)
 CPW90 Working Frequency [246](#)
 Customizing Your Phone [58](#)

D

Deleting a Line Key [106](#)
 Deleting Contacts [88](#)
 Deleting Groups [85](#)
 Deleting History Records [101](#)
 Deleting the Recorded Audios [128](#)
 Directed Call Pickup [171](#)
 Dial-now [117](#)
 Dial Plan [115](#)
 Dialing Screen [33](#)
 Disabling History Records [103](#)
 Disabling Wi-Fi Feature [56](#)
 Disconnecting the Bluetooth Device [229](#)
 Disconnecting the Wireless Network Connection [55](#)
 Documentations [23](#)

E

Editing Contacts [88](#)
 Editing Device Information [232](#)
 Editing Groups [84](#)
 Emergency Number [121](#)
 Ending Calls [142](#)
 Entering Data and Editing Fields [38](#)
 Exchanging Places of Line Keys [105](#)

F

- Feature Status Icons [15](#)
- Forwarding Incoming Calls [146](#)
- Finding the CPW90 [245](#)
- FWD International [123](#)

G

- General Settings [58](#)
- Getting Started [25](#)
- Group Call Pickup [173](#)

H

- Handling Incoming Calls [144](#)
- Hardware Component Instructions [13](#)
- Hotline [122](#)
- Hot Desking [193](#)

I

- Icon Instructions [15](#)
- Idle Mode [244](#)
- Idle Screen [30](#)
- Importing/Exporting Contact lists [93](#)
- In This Guide [v](#)
- Incoming/Outgoing Call Lookup [99](#)
- Incoming Intercom Calls [196](#)
- Input Method [67](#)
- Intercom [195](#)

K

- Key Tone [80](#)

L

- Language [66](#)
- Leaving Voice Mails [221](#)
- LED Instructions [20](#)
- Line Key Icons [16](#)
- Line Key Features [107](#)
- Line Keys [104](#)
- Live Dialpad [121](#)
- Listening to Voice Mails [222](#)
- Local Conference [162](#)
- Local Directory [83](#)

M

- Making the Phone Discoverable [228](#)
- Making/Receiving a Mobile Call on the IP Phone [229](#)
- Managing Bookmarks [131](#)
- Managing Recorded Audios [125](#)
- Managing the PC Audio [236](#)
- Manually Connect an Available Wireless Network [50](#)
- Message [221](#)
- Message Waiting Indicator (MWI) [223](#)
- Modifying Browser Settings [135](#)
- Multicast Paging [198](#)

- Multiple Line Keys per Account [115](#)
- Muting or Unmuting the CPW90 [244](#)
- Muting or Unmuting the Microphone [237](#)
- Music on Hold [205](#)
- Mute a Call [155](#)

N

- Navigating Menus and Fields [38](#)
- Network Conference [168](#)
- Notification Sound [81](#)

O

- Other Icons [17](#)
- Outgoing Intercom Calls [195](#)
- Overview [13](#)
- Optional Accessories [26](#)

P

- Packaging Contents [25](#)
- Pairing and Connecting the Bluetooth Device [226](#)
- Phone Initialization [29](#)
- Phone Installation [27](#)
- Phone Lock [71](#)
- Phone Status [44](#)
- Phone User Interface [20](#)
- Placing a Call [139](#)
- Placing a Call from History Records [100](#)
- Placing a Mobile Call over Bluetooth [140](#)
- Placing Calls [139](#)
- Placing Calls to Contacts [91](#)
- Placing Multiple Calls [140](#)
- Placing the CPW90 [241](#)
- Placing the PC Audio on Hold [237](#)
- Playing the Recorded Audios [125](#)
- Power Saving [61](#)

R

- Recall [154](#)
- Recent Call In Dialing [150](#)
- Receiving RTP Stream [202](#)
- Recorder [124](#)
- Recording Audios [124](#)
- Redialing Numbers [149](#)
- Registration [30](#)
- Registering/Unregistering the CPW90 [244](#)
- Rejecting an Incoming Call [144](#)
- Rejecting Calls with Do Not Disturb (DND) Enabled [144](#)
- Renaming the Paired Bluetooth Device [229](#)
- Renaming the Recorded Audios [128](#)
- Remote Phone Book [97](#)
- Removing the PC Audio [238](#)
- Replace Rule [116](#)
- Ring Tones [77](#)

S

- Screen Saver [60](#)
- Search Source List in Dialing [103](#)
- Semi-Attended Transfer [160](#)
- Searching for Contacts [92](#)
- Sending RTP Stream [198](#)
- Setting a Home Page [133](#)
- Setting the IP Phone as PC Audio Device [238](#)
- Setting the IP Phone as PC Audio Device via PC [239](#)
- Setting the IP Phone as PC Audio Device via Yealink VC Desktop [238](#)
- Shared Call Appearance (SCA) [207](#)
- Silencing an Incoming Call [144](#)
- Silent Mode [81](#)
- Speed Dial [149](#)
- System Applications [124](#)
- System Customizations [104](#)

T

- Table of Contents [vii](#)
- Touch Sounds [80](#)
- Time & Date [68](#)
- Turning On or Off the CPW90 [242](#)

U

- Unpairing the Bluetooth Device [233](#)
- Uploading Contact Photos [90](#)
- Uploading the Custom Picture via Web User Interfaces [20](#)
- Using BLF Feature on the Phone [184](#)
- Using the CP Wireless Expansion Mic CPW90 [241](#)
- Using the Onscreen Keyboard [39](#)
- Using the Onscreen Dial Pad [44](#)
- Using the Touch Screen [30](#)
- Using Intercom Feature on the Phone [197](#)
- Using Multicast Paging [203](#)
- Using Your IP Phone as Bluetooth Speaker [230](#)
- Using SCA Feature on the IP Phone [213](#)

V

- Volume [75](#)
- Viewing CPW90 Information [244](#)
- Viewing Detail Information of the Viewing History Records [99](#)
- Viewing the Connected Wireless Network Information [55](#)
- Voice Mail [221](#)

W

- Wallpaper [58](#)
- Web User Interface [21](#)
- Wi-Fi Protected Setup (WPS) [51](#)
- Wireless Network Settings [49](#)